

USER MANUAL

wall-mounted ion hair dryer

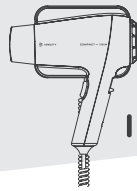

Indoor Use

please read user manual carefully before using.

Safety Caution

Ignoring or misunderstanding these signs, following two cases may occur:

Warning	This "Warning Sign" means: Dangers may occur.	Attention	This "Note Sign" means: Damage to the product.
Instruction	Prohibited	A must	Do not open
			Keep away from fire

Warning		Attention	
Absolutely not to disassemble, repair, renovate personally, etc.	1 Please remember to respect the local regulations: hand in the non-working electrical equipments to an appropriate waste disposal centre. The packaging material is recyclable. Dispose of the packaging in an environmentally friendly manner and make it available for the recyclable material collection-service.	Please use standard voltage power socket, and use separately with other appliances.	
Keep away from fire.	2 If the supply cord is damaged, it must be replaced by the manufacturer, its service agent or similarly qualified persons in order to avoid a hazard.	To ensure safety, it is recommended that to install a rated leakage protection switch in the bathroom power supply circuit.	
The wind outlet still hot after finished working, please do not touch.	3 This appliance is not intended for use by persons (including children) with reduced physical, sensory or mental capabilities, or lack of experience and knowledge, unless they have been given supervision or instruction concerning use of the appliance by a person responsible for their safety. Children should be supervised to ensure that they do not play with the appliance.	Do not place the hair dryer in highly humid place.	
Do not block the wind inlet.	4 If the hand-held part of the hairdryer incorporates electrical components, the instructions shall state that the appliance must be fixed so that the hand-held part, when fully extended, is out of reach of a person taking a bath or shower.	Do not use any corrosive chemicals to clean the hair dryer.	
Children or disabled person should be accompanied by adults to use this product.	5 This hairdryer must be fixed out of reach of a person taking a bath or shower.	Do not wash with water, clean the hair dryer by dry towel.	
Do not use the hair dryer with a wet hand.			
Do not put objects into wind outlet or wind inlet, to avoid electric shock;			
Do not let your hair wind in hair dryer.			

Unit Specification

Product	Hair dryer
Input voltage	AC 220-240V ~ 50Hz-60Hz
Maximum power	1800W current 7.8A
Constant power	1100W current 4.7A
Cool wind power	230W current 1.0A
Overheating protection	90°C 157°C
Unit Size	195x97x227mm

Function

- The Anion Generator will release the ion when hair dryer starts working, The anion helps against static, easy to comb your hair. The Anion will release the smells while it's working, it's no harmless.
- Just press the startup switch to use the hair dryer, release it to stop working.
- Double overheating protection to prevent any abnormal issue happen.
- 3 temperature option: High, warm, cool.
- 1800W high power to dry hair faster.

Installation

Please choose a dry place to install the hair dryer.

1. Choose a location to install the hair dryer, mark 2 drilling holes according to the paper template.

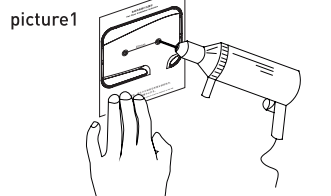

2. Drill 2 holes then insert 2 plastic plugs.

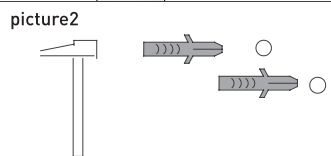

3. Screw the holder into the wall tightly.

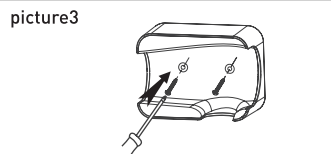

4. Cover up the screw holes by the two plastic caps.

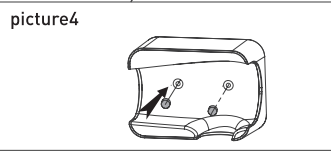

5. Put the hair dryer back to the holder.

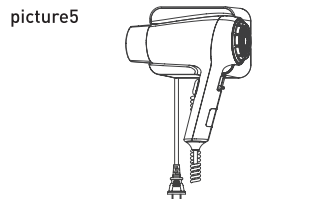

Component

- ① Wind outlet
- ② Hair dryer
- ③ Startup switch
- ④ Power line
- ⑤ Hair dryer holder
- ⑥ Wind inlet
- ⑦ Toggle adjustor
- ⑧ Spring line

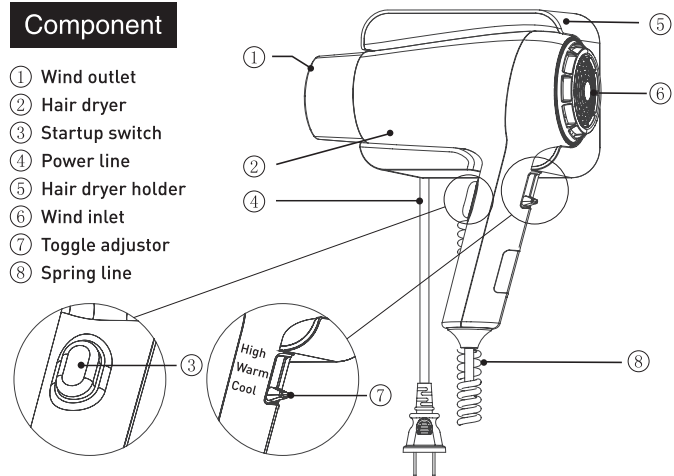

Accessories

Plastic plugs X 2PCS	Screws X 2PCS	Plastic caps X 2pcs
----------------------	---------------	---------------------

Operation

1. Pick up the hair dryer after powered on, press the startup switch to use it. To adjust the temperature by the toggle switch.
2. Please do not touch the Wind outlet while it is working.
3. Please stop using the hair dryer if you see the hair dryer interior turns red and sparking, contact with the professional maintenance personnel.
4. Take out the power plug if no use.