



Verification Report

No.: GZ0907067874/CHEM

Date: NOV 09, 2009

Page 1 of 45

ZHEJIANG YIWU CHINA SMALL-COMMODITIES CITY TRADING CO., LTD.
5TH FLOOR, G DISTRICT INTERNATIONAL TRADE CITY, YIWU, ZHEJIANG, CHINA

Sample Description : Auto Soap Dispenser
SGS Ref No. : SZ12032041
Model No. (P.O No.) : SEPTIplus
Buyer(s) : Genie et Environnement
Verification Period : JUL 22, 2009 TO NOV 09, 2009

Verification Requested : With reference to RoHS Directive 2002/95/EC, and its amendment directives

Verification Method

1. Review was performed for the samples disjointed from the submitted articles and the related test reports submitted by the Applicant
2. Tests was performed for the samples indicated by the photos in the report with test methods reference to IEC 62321:2008: Procedures for the Determination of Levels of Six Regulated substances in Electrotechnical Products
 - (1) Screening by XRF Spectroscopy
 - (2) Wet Chemical Test Method
 - a. Determination of Lead & Cadmium by ICP and AAS.
 - b. Determination of Hexavalent Chromium by Colorimetric Method.
 - c. Determination of PBBs and PBDEs by GC/MS.

Verification Results : Please refer to next page

Verification Conclusion : Based on the review of previous reports and verification results of the submitted samples, the results **comply with** the RoHS Directive 2002/95/EC and its subsequent amendments.

Signed for and on behalf of
SGS-CSTC Ltd.

Shining Deng
Sr. Engineer

This document is issued by the Company under its General Conditions of Service printed overleaf or available on request and accessible at http://www.sgs.com/terms_and_conditions.htm. Attention is drawn to the limitation of liability, indemnification and jurisdiction issues defined therein. Any holder of this document is advised that information contained hereon reflects the Company's findings at the time of its intervention only and within the limits of Client's instructions, if any. The Company's sole responsibility is to its Client and this document does not constitute parties to a transaction from exercising all their rights and obligations under the transaction documents. Any unauthorized alteration, forgery or falsification of the content or appearance of this document is unlawful and offenders may be prosecuted to the fullest extent of the law. Unless otherwise stated the results shown in this test report refer only to the sample(s) tested. This document cannot be reproduced except in full, without prior approval of the Company.



SGS Standards Technics Services Co., Ltd.
Guangzhou Environmental Chemical Laboratory

130 Kazhu Road, Sofoitech Park, Guangzhou Economic & Technology Development District, Guangzhou, China 510663 | (86-20) 82155555 | (86-20) 82075125 | www.cn.sgs.com
中国·广州·经济技术开发区科学城科珠路198号 邮编: 510663 | (86-20) 82155555 | (86-20) 82075125 | e sgs.china@sgs.com

Member of the SGS Group (SGS SA)

Details on Verification

Part No.	Part Name	Restricted Substances	Results of EDXRF ⁽¹⁾	No. of Related Test Report	Results in Related Test Report(mg/kg)	Result of Wet Chemical Testing ⁽²⁾ (mg/kg)	Conclusion on RoHS	Sample Submitted / Resubmitted Date
1	White plastic shell	Cd	BL	\	\	\	Comply	Jul 22, 2009
		Pb	BL		\	\	Comply	
		Hg	BL		\	\	Comply	
		Cr ⁶⁺	BL		\	\	Comply	
		PBBs	BL		\	\	Comply	
		PBDEs			\	\	Comply	
2	Lt-blue plastic shell (on No.1)	Cd	BL	\	\	\	Comply	Jul 22, 2009
		Pb	BL		\	\	Comply	
		Hg	BL		\	\	Comply	
		Cr ⁶⁺	BL		\	\	Comply	
		PBBs	BL		\	\	Comply	
		PBDEs			\	\	Comply	
3	Silvery adhesive plastic sheet w/ black printing (label on No.1)	Cd	BL	\	\	\	Comply	Jul 22, 2009
		Pb	BL		\	\	Comply	
		Hg	BL		\	\	Comply	
		Cr ⁶⁺	BL		\	\	Comply	
		PBBs	BL		\	\	Comply	
		PBDEs			\	\	Comply	
4	White plastic sheet (on No.1)	Cd	BL	\	\	\	Comply	Jul 22, 2009
		Pb	BL		\	\	Comply	
		Hg	BL		\	\	Comply	
		Cr ⁶⁺	BL		\	\	Comply	
		PBBs	BL		\	\	Comply	
		PBDEs			\	\	Comply	
5	Silvery metal screw (on No.4)	Cd	BL	\	\	\	Comply	Jul 22, 2009
		Pb	BL		\	\	Comply	
		Hg	BL		\	\	Comply	
		Cr ⁶⁺	IN		\	Negative	Comply	
		PBBs	---		\	\	\	
		PBDEs			\	\	\	
6	White adhesive plastic sheet w/ black printing (label on No.2)	Cd	BL	\	\	\	Comply	Jul 22, 2009
		Pb	BL		\	\	Comply	
		Hg	BL		\	\	Comply	
		Cr ⁶⁺	BL		\	\	Comply	
		PBBs	BL		\	\	Comply	
		PBDEs			\	\	Comply	
7-C	Silvery metal tube (on No.2)	Cd	BL	\	\	\	Comply	Jul 22, 2009/ Aug 26, 2009
		Pb	IN		\	26528 (See remark ⁽¹⁾)	Comply	
		Hg	BL		\	\	Comply	
		Cr ⁶⁺	BL		\	\	Comply	
		PBBs	---		\	\	\	
		PBDEs			\	\	\	

This document is issued by the Company under its General Conditions of Service printed overleaf or available on request and accessible at http://www.sgs.com/terms_and_conditions.htm. Attention is drawn to the limitation of liability, indemnification and jurisdiction issues defined therein. Any holder of this document is advised that information contained hereon reflects the Company's findings at the time of its intervention only and within the limits of Client's instructions, if any. The Company's sole responsibility is to its Client and this document does not generate parties to a transaction from exercising all their rights and obligations under the transaction documents. Any unauthorized alteration, forgery or falsification of the content or appearance of this document is unlawful and offenders may be prosecuted to the fullest extent of the law. Unless otherwise stated, the results shown in this test report refer only to the sample(s) tested. This document cannot be reproduced except in full, without prior approval of the Company.



Part No.	Part Name	Restricted Substances	Results of EDXRF ⁽¹⁾	No. of Related Test Report	Results in Related Test Report(mg/kg)	Result of Wet Chemical Testing ⁽²⁾ (mg/kg)	Conclusion on RoHS	Sample Submitted / Resubmitted Date
8-C	Silvery metal nut (on No.7)	Cd	BL	\	\	\	Comply	Jul 22, 2009/ Aug 26, 2009/ Oct 26, 2009
		Pb	IN		\	26636 (See remark ^[2])	Comply	
		Hg	BL		\	\	Comply	
		Cr ⁶⁺	BL		\	\	Comply	
		PBBs	---		\	\	\	
		PBDEs	---		\	\	\	
9	Translucent rubber part (on No.2)	Cd	BL	\	\	\	Comply	Jul 22, 2009
		Pb	BL		\	\	Comply	
		Hg	BL		\	\	Comply	
		Cr ⁶⁺	BL		\	\	Comply	
		PBBs	---		\	\	Comply	
		PBDEs	BL		\	\	Comply	
10	Silvery metal screw (on No.2)	Cd	BL	\	\	\	Comply	Jul 22, 2009
		Pb	BL		\	\	Comply	
		Hg	BL		\	\	Comply	
		Cr ⁶⁺	IN		\	Negative	Comply	
		PBBs	---		\	\	\	
		PBDEs	---		\	\	\	
11	White plastic part (in No.2)	Cd	BL	\	\	\	Comply	Jul 22, 2009
		Pb	BL		\	\	Comply	
		Hg	BL		\	\	Comply	
		Cr ⁶⁺	BL		\	\	Comply	
		PBBs	---		\	\	Comply	
		PBDEs	BL		\	\	Comply	
12	Silvery metal screw (on No.11)	Cd	BL	\	\	\	Comply	Jul 22, 2009
		Pb	BL		\	\	Comply	
		Hg	BL		\	\	Comply	
		Cr ⁶⁺	IN		\	Negative	Comply	
		PBBs	---		\	\	\	
		PBDEs	---		\	\	\	
13	Translucent glue (on No.11)	Cd	BL	\	\	\	Comply	Jul 22, 2009
		Pb	BL		\	\	Comply	
		Hg	BL		\	\	Comply	
		Cr ⁶⁺	BL		\	\	Comply	
		PBBs	---		\	\	Comply	
		PBDEs	BL		\	\	Comply	
14	White plastic rod (connected w/ No.11)	Cd	BL	\	\	\	Comply	Jul 22, 2009
		Pb	BL		\	\	Comply	
		Hg	BL		\	\	Comply	
		Cr ⁶⁺	BL		\	\	Comply	
		PBBs	---		\	\	Comply	
		PBDEs	BL		\	\	Comply	

This document is issued by the Company under its General Conditions of Service printed overleaf or available on request and accessible at http://www.sgs.com/terms_and_conditions.htm. Attention is drawn to the limitation of liability, indemnification and jurisdiction issues defined therein. Any holder of this document is advised that information contained hereon reflects the Company's findings at the time of its intervention only and within the limits of Client's instructions, if any. The Company's sole responsibility is to its Client and this document does not generate parties to a transaction from exercising all their rights and obligations under the transaction documents. Any unauthorized alteration, forgery or falsification of the content or appearance of this document is unlawful and offenders may be prosecuted to the fullest extent of the law. Unless otherwise stated, the results shown in this test report refer only to the sample(s) tested. This document cannot be reproduced except in full, without prior approval of the Company.



Part No.	Part Name	Restricted Substances	Results of EDXRF ⁽¹⁾	No. of Related Test Report	Results in Related Test Report(mg/kg)	Result of Wet Chemical Testing ⁽²⁾ (mg/kg)	Conclusion on RoHS	Sample Submitted / Resubmitted Date
15	Transparent plastic tube (connected w/ No.14)	Cd	BL	\	\	\	Comply	Jul 22, 2009
		Pb	BL		\	\	Comply	
		Hg	BL		\	\	Comply	
		Cr ⁶⁺	BL		\	\	Comply	
		PBBs	BL		\	\	Comply	
		PBDEs			\	\	Comply	
16	White plastic shell (connected w/ No.15)	Cd	BL	\	\	\	Comply	Jul 22, 2009
		Pb	BL		\	\	Comply	
		Hg	BL		\	\	Comply	
		Cr ⁶⁺	BL		\	\	Comply	
		PBBs	BL		\	\	Comply	
		PBDEs			\	\	Comply	
17	Silvery metal screw (on No.16)	Cd	BL	\	\	\	Comply	Jul 22, 2009
		Pb	BL		\	\	Comply	
		Hg	BL		\	\	Comply	
		Cr ⁶⁺	IN		\	Negative	Comply	
		PBBs	---		\	\	\	
		PBDEs			\	\	\	
18	Silvery metal spring (in No.16)	Cd	BL	\	\	\	Comply	Jul 22, 2009
		Pb	BL		\	\	Comply	
		Hg	BL		\	\	Comply	
		Cr ⁶⁺	IN		\	Negative	Comply	
		PBBs	---		\	\	\	
		PBDEs			\	\	\	
19	Red rubber part (in No.16)	Cd	BL	\	\	\	Comply	Jul 22, 2009
		Pb	BL		\	\	Comply	
		Hg	BL		\	\	Comply	
		Cr ⁶⁺	BL		\	\	Comply	
		PBBs	BL		\	\	Comply	
		PBDEs			\	\	Comply	
20	White plastic (tie) (on No.16)	Cd	BL	\	\	\	Comply	Jul 22, 2009
		Pb	BL		\	\	Comply	
		Hg	BL		\	\	Comply	
		Cr ⁶⁺	BL		\	\	Comply	
		PBBs	BL		\	\	Comply	
		PBDEs			\	\	Comply	
21	Translucent rubber tube (connected w/ No.16)	Cd	BL	\	\	\	Comply	Jul 22, 2009
		Pb	BL		\	\	Comply	
		Hg	BL		\	\	Comply	
		Cr ⁶⁺	BL		\	\	Comply	
		PBBs	BL		\	\	Comply	
		PBDEs			\	\	Comply	

This document is issued by the Company under its General Conditions of Service printed overleaf or available on request and accessible at http://www.sgs.com/terms_and_conditions.htm. Attention is drawn to the limitation of liability, indemnification and jurisdiction issues defined therein. Any holder of this document is advised that information contained hereon reflects the Company's findings at the time of its intervention only and within the limits of Client's instructions, if any. The Company's sole responsibility is to its Client and this document does not generate parties to a transaction from exercising all their rights and obligations under the transaction documents. Any unauthorized alteration, forgery or falsification of the content or appearance of this document is unlawful and offenders may be prosecuted to the fullest extent of the law. Unless otherwise stated, the results shown in this test report refer only to the sample(s) tested. This document cannot be reproduced except in full, without prior approval of the Company.





Verification Report

No.: GZ0907067874/CHEM

Date: NOV 09, 2009

Page 5 of 45

Part No.	Part Name	Restricted Substances	Results of EDXRF ⁽¹⁾	No. of Related Test Report	Results in Related Test Report(mg/kg)	Result of Wet Chemical Testing ⁽²⁾ (mg/kg)	Conclusion on RoHS	Sample Submitted / Resubmitted Date
22	White plastic (connected w/ No.21)	Cd	BL	\	\	\	Comply	Jul 22, 2009
		Pb	BL		\	\	Comply	
		Hg	BL		\	\	Comply	
		Cr ⁶⁺	BL		\	\	Comply	
		PBBs	BL		\	\	Comply	
		PBDEs			\	\	Comply	
23	Translucent rubber part (on No.22)	Cd	BL	\	\	\	Comply	Jul 22, 2009
		Pb	BL		\	\	Comply	
		Hg	BL		\	\	Comply	
		Cr ⁶⁺	BL		\	\	Comply	
		PBBs	BL		\	\	Comply	
		PBDEs			\	\	Comply	
24	Green "PCB" (small) (in No.2)	Cd	BL	\	\	\	Comply	Jul 22, 2009
		Pb	BL		\	\	Comply	
		Hg	BL		\	\	Comply	
		Cr ⁶⁺	BL		\	\	Comply	
		PBBs	IN		\	N.D.	Comply	
		PBDEs			\	N.D.	Comply	
25	Red transparent plastic sheet (in No.2)	Cd	BL	\	\	\	Comply	Jul 22, 2009
		Pb	BL		\	\	Comply	
		Hg	BL		\	\	Comply	
		Cr ⁶⁺	BL		\	\	Comply	
		PBBs	BL		\	\	Comply	
		PBDEs			\	\	Comply	
26	Black sponge part (on No.24)	Cd	BL	\	\	\	Comply	Jul 22, 2009
		Pb	BL		\	\	Comply	
		Hg	BL		\	\	Comply	
		Cr ⁶⁺	BL		\	\	Comply	
		PBBs	BL		\	\	Comply	
		PBDEs			\	\	Comply	
27	Beige plastic (housing) (J6 on No.24)	Cd	BL	\	\	\	Comply	Jul 22, 2009
		Pb	BL		\	\	Comply	
		Hg	BL		\	\	Comply	
		Cr ⁶⁺	BL		\	\	Comply	
		PBBs	BL		\	\	Comply	
		PBDEs			\	\	Comply	
28	Silvery metal pin (in No.27)	Cd	BL	\	\	\	Comply	Jul 22, 2009
		Pb	BL		\	\	Comply	
		Hg	BL		\	\	Comply	
		Cr ⁶⁺	BL		\	\	Comply	
		PBBs	---		\	\	\	
		PBDEs			\	\	\	

This document is issued by the Company under its General Conditions of Service printed overleaf or available on request and accessible at http://www.sgs.com/terms_and_conditions.htm. Attention is drawn to the limitation of liability, indemnification and jurisdiction issues defined therein. Any holder of this document is advised that information contained hereon reflects the Company's findings at the time of its intervention only and within the limits of Client's instructions, if any. The Company's sole responsibility is to its Client and this document does not constitute parties to a transaction from exercising all their rights and obligations under the transaction documents. Any unauthorized alteration, forgery or falsification of the content or appearance of this document is unlawful and offenders may be prosecuted to the fullest extent of the law. Unless otherwise stated, the results shown in this test report refer only to the sample(s) tested. This document cannot be reproduced except in full, without prior approval of the Company.



130 Kazhu Road, Sointech Park, Guangzhou Economic & Technology Development District, Guangzhou, China 510663 | (86-20) 82155555 | (86-20) 82075125 | www.cn.sgs.com
 中国·广州·经济技术开发区科学城科珠路198号 邮编: 510663 | (86-20) 82155555 | (86-20) 82075125 | e sgs.china@sgs.com

Member of the SGS Group (SGS SA)



Verification Report

No.: GZ0907067874/CHEM

Date: NOV 09, 2009

Page 6 of 45

Part No.	Part Name	Restricted Substances	Results of EDXRF ⁽¹⁾	No. of Related Test Report	Results in Related Test Report(mg/kg)	Result of Wet Chemical Testing ⁽²⁾ (mg/kg)	Conclusion on RoHS	Sample Submitted / Resubmitted Date
29	Silvery metal sheet (on No.27)	Cd	BL	\	\	\	Comply	Jul 22, 2009
		Pb	BL		\	\	Comply	
		Hg	BL		\	\	Comply	
		Cr ⁶⁺	BL		\	\	Comply	
		PBBs	---		\	\	\	
		PBDEs	---		\	\	\	
30	White plastic (socket) (connected w/ No.27)	Cd	BL	\	\	\	Comply	Jul 22, 2009
		Pb	BL		\	\	Comply	
		Hg	BL		\	\	Comply	
		Cr ⁶⁺	BL		\	\	Comply	
		PBBs	BL		\	\	Comply	
		PBDEs	---		\	\	Comply	
31	Silvery metal terminal (in No.30)	Cd	BL	\	\	\	Comply	Jul 22, 2009
		Pb	BL		\	\	Comply	
		Hg	BL		\	\	Comply	
		Cr ⁶⁺	BL		\	\	Comply	
		PBBs	---		\	\	\	
		PBDEs	---		\	\	\	
32	Black plastic (wire insulation) (connected w/ No.31)	Cd	BL	\	\	\	Comply	Jul 22, 2009
		Pb	BL		\	\	Comply	
		Hg	BL		\	\	Comply	
		Cr ⁶⁺	BL		\	\	Comply	
		PBBs	BL		\	\	Comply	
		PBDEs	---		\	\	Comply	
33	Black adhesive fiber tape (on No.32)	Cd	BL	\	\	\	Comply	Jul 22, 2009
		Pb	BL		\	\	Comply	
		Hg	BL		\	\	Comply	
		Cr ⁶⁺	BL		\	\	Comply	
		PBBs	BL		\	\	Comply	
		PBDEs	---		\	\	Comply	
34	Silvery metal wire (in No.32)	Cd	BL	\	\	\	Comply	Jul 22, 2009
		Pb	BL		\	\	Comply	
		Hg	BL		\	\	Comply	
		Cr ⁶⁺	BL		\	\	Comply	
		PBBs	---		\	\	\	
		PBDEs	---		\	\	\	
35	White plastic shell (big) (in No.2)	Cd	BL	\	\	\	Comply	Jul 22, 2009
		Pb	BL		\	\	Comply	
		Hg	BL		\	\	Comply	
		Cr ⁶⁺	BL		\	\	Comply	
		PBBs	---		\	\	Comply	
		PBDEs	---		\	\	Comply	

This document is issued by the Company under its General Conditions of Service printed overleaf or available on request and accessible at http://www.sgs.com/terms_and_conditions.htm. Attention is drawn to the limitation of liability, indemnification and jurisdiction issues defined therein. Any holder of this document is advised that information contained hereon reflects the Company's findings at the time of its intervention only and within the limits of Client's instructions, if any. The Company's sole responsibility is to its Client and this document does not constitute parties to a transaction from exercising all their rights and obligations under the transaction documents. Any unauthorized alteration, forgery or falsification of the content or appearance of this document is unlawful and offenders may be prosecuted to the fullest extent of the law. Unless otherwise stated, the results shown in this test report refer only to the sample(s) tested. This document cannot be reproduced except in full, without prior approval of the Company.



130 Kazhu Road, Sointech Park, Guangzhou Economic & Technology Development District, Guangzhou, China 510663 | (86-20) 82155555 | (86-20) 82075125 | www.cn.sgs.com
 中国·广州·经济技术开发区科学城科珠路198号 邮编: 510663 | (86-20) 82155555 | (86-20) 82075125 | e.sgs.china@sgs.com

Member of the SGS Group (SGS SA)



Verification Report

No.: GZ0907067874/CHEM

Date: NOV 09, 2009

Page 7 of 45

Part No.	Part Name	Restricted Substances	Results of EDXRF ⁽¹⁾	No. of Related Test Report	Results in Related Test Report(mg/kg)	Result of Wet Chemical Testing ⁽²⁾ (mg/kg)	Conclusion on RoHS	Sample Submitted / Resubmitted Date
36	Silvery metal (motor shell) (on No.35)	Cd	BL	\	\	\	Comply	Jul 22, 2009
		Pb	BL		\	\	Comply	
		Hg	BL		\	\	Comply	
		Cr ⁶⁺	BL		\	\	Comply	
		PBBs	---		\	\	\	
		PBDEs	---		\	\	\	
37	White plastic gear (big) (in No.35)	Cd	BL	\	\	\	Comply	Jul 22, 2009
		Pb	BL		\	\	Comply	
		Hg	BL		\	\	Comply	
		Cr ⁶⁺	BL		\	\	Comply	
		PBBs	BL		\	\	Comply	
		PBDEs	---		\	\	Comply	
38	White plastic gear (small) (in No.35)	Cd	BL	\	\	\	Comply	Jul 22, 2009
		Pb	BL		\	\	Comply	
		Hg	BL		\	\	Comply	
		Cr ⁶⁺	BL		\	\	Comply	
		PBBs	BL		\	\	Comply	
		PBDEs	---		\	\	Comply	
39	Silvery metal screw (in No.35)	Cd	BL	\	\	\	Comply	Jul 22, 2009
		Pb	BL		\	\	Comply	
		Hg	BL		\	\	Comply	
		Cr ⁶⁺	IN		\	Negative	Comply	
		PBBs	---		\	\	\	
		PBDEs	---		\	\	\	
40	Silvery metal rod (motor shaft) (in No.36)	Cd	BL	\	\	\	Comply	Jul 22, 2009
		Pb	BL		\	\	Comply	
		Hg	BL		\	\	Comply	
		Cr ⁶⁺	IN		\	Negative	Comply	
		PBBs	---		\	\	\	
		PBDEs	---		\	\	\	
41	Golden metal ring (on No.36)	Cd	BL	\	\	\	Comply	Jul 22, 2009
		Pb	BL		\	\	Comply	
		Hg	BL		\	\	Comply	
		Cr ⁶⁺	BL		\	\	Comply	
		PBBs	---		\	\	\	
		PBDEs	---		\	\	\	
42	Dk-grey core (in No.36)	Cd	BL	\	\	\	Comply	Jul 22, 2009
		Pb	BL		\	\	Comply	
		Hg	BL		\	\	Comply	
		Cr ⁶⁺	BL		\	\	Comply	
		PBBs	---		\	\	Comply	
		PBDEs	BL		\	\	Comply	

This document is issued by the Company under its General Conditions of Service printed overleaf or available on request and accessible at http://www.sgs.com/terms_and_conditions.htm. Attention is drawn to the limitation of liability, indemnification and jurisdiction issues defined therein. Any holder of this document is advised that information contained hereon reflects the Company's findings at the time of its intervention only and within the limits of Client's instructions, if any. The Company's sole responsibility is to its Client and this document does not constitute parties to a transaction from exercising all their rights and obligations under the transaction documents. Any unauthorized alteration, forgery or falsification of the content or appearance of this document is unlawful and offenders may be prosecuted to the fullest extent of the law. Unless otherwise stated, the results shown in this test report refer only to the sample(s) tested. This document cannot be reproduced except in full, without prior approval of the Company.



130 Kazhu Road, Sointech Park, Guangzhou Economic & Technology Development District, Guangzhou, China 510663 | (86-20) 82155555 | (86-20) 82075125 | www.cn.sgs.com
 中国·广州·经济技术开发区科学城科珠路198号 邮编: 510663 | (86-20) 82155555 | (86-20) 82075125 | e sgs.china@sgs.com

Member of the SGS Group (SGS SA)



Verification Report

No.: GZ0907067874/CHEM

Date: NOV 09, 2009

Page 8 of 45

Part No.	Part Name	Restricted Substances	Results of EDXRF ⁽¹⁾	No. of Related Test Report	Results in Related Test Report(mg/kg)	Result of Wet Chemical Testing ⁽²⁾ (mg/kg)	Conclusion on RoHS	Sample Submitted / Resubmitted Date
43-C	Silvery metal (silicon steel sheet) (in No.36)	Cd	BL	\	\	\	Comply	Jul 22, 2009/ Sep 29, 2009/ Oct 26, 2009
		Pb	BL		\	\	Comply	
		Hg	BL		\	\	Comply	
		Cr ⁶⁺	IN		\	Negative	Comply	
		PBBs	---		\	\	\	
		PBDEs	---		\	\	\	
44	White plastic sheet (on No.43)	Cd	BL	\	\	\	Comply	Jul 22, 2009
		Pb	BL		\	\	Comply	
		Hg	BL		\	\	Comply	
		Cr ⁶⁺	BL		\	\	Comply	
		PBBs	BL		\	\	Comply	
		PBDEs	BL		\	\	Comply	
45	White plastic cover (on No.36)	Cd	BL	\	\	\	Comply	Jul 22, 2009
		Pb	BL		\	\	Comply	
		Hg	BL		\	\	Comply	
		Cr ⁶⁺	BL		\	\	Comply	
		PBBs	BL		\	\	Comply	
		PBDEs	BL		\	\	Comply	
46	Silvery / copper-colored metal sheet (on No.40)	Cd	BL	\	\	\	Comply	Jul 22, 2009
		Pb	BL		\	\	Comply	
		Hg	BL		\	\	Comply	
		Cr ⁶⁺	BL		\	\	Comply	
		PBBs	---		\	\	\	
		PBDEs	---		\	\	\	
47	White plastic ring (on No.46)	Cd	BL	\	\	\	Comply	Jul 22, 2009
		Pb	BL		\	\	Comply	
		Hg	BL		\	\	Comply	
		Cr ⁶⁺	BL		\	\	Comply	
		PBBs	BL		\	\	Comply	
		PBDEs	BL		\	\	Comply	
48	Red material ring (on No.46)	Cd	BL	\	\	\	Comply	Jul 22, 2009
		Pb	BL		\	\	Comply	
		Hg	BL		\	\	Comply	
		Cr ⁶⁺	BL		\	\	Comply	
		PBBs	BL		\	\	Comply	
		PBDEs	BL		\	\	Comply	
49	Black material ring w/ silvery surface (on No.46)	Cd	BL	\	\	\	Comply	Jul 22, 2009
		Pb	BL		\	\	Comply	
		Hg	BL		\	\	Comply	
		Cr ⁶⁺	BL		\	\	Comply	
		PBBs	BL		\	\	Comply	
		PBDEs	BL		\	\	Comply	

This document is issued by the Company under its General Conditions of Service printed overleaf or available on request and accessible at http://www.sgs.com/terms_and_conditions.htm. Attention is drawn to the limitation of liability, indemnification and jurisdiction issues defined therein. Any holder of this document is advised that information contained hereon reflects the Company's findings at the time of its intervention only and within the limits of Client's instructions, if any. The Company's sole responsibility is to its Client and this document does not constitute parties to a transaction from exercising all their rights and obligations under the transaction documents. Any unauthorized alteration, forgery or falsification of the content or appearance of this document is unlawful and offenders may be prosecuted to the fullest extent of the law. Unless otherwise stated, the results shown in this test report refer only to the sample(s) tested. This document cannot be reproduced except in full, without prior approval of the Company.



130 Kazhu Road, Sointech Park, Guangzhou Economic & Technology Development District, Guangzhou, China 510663 | (86-20) 82155555 | (86-20) 82075125 | www.cn.sgs.com
 中国·广州·经济技术开发区科学城科珠路198号 邮编: 510663 | (86-20) 82155555 | (86-20) 82075125 | e.sgs.china@sgs.com

Member of the SGS Group (SGS SA)



Verification Report

No.: GZ0907067874/CHEM

Date: NOV 09, 2009

Page 9 of 45

Part No.	Part Name	Restricted Substances	Results of EDXRF ⁽¹⁾	No. of Related Test Report	Results in Related Test Report(mg/kg)	Result of Wet Chemical Testing ⁽²⁾ (mg/kg)	Conclusion on RoHS	Sample Submitted / Resubmitted Date
50	Silvery metal (solder on No.49)	Cd	BL	\	\	\	Comply	Jul 22, 2009
		Pb	BL		\	\	Comply	
		Hg	BL		\	\	Comply	
		Cr ⁶⁺	BL		\	\	Comply	
		PBBs	---		\	\	\	
		PBDEs	---		\	\	\	
51	White plastic ring (on No.40)	Cd	BL	\	\	\	Comply	Jul 22, 2009
		Pb	BL		\	\	Comply	
		Hg	BL		\	\	Comply	
		Cr ⁶⁺	BL		\	\	Comply	
		PBBs	BL		\	\	Comply	
		PBDEs	BL		\	\	Comply	
52	Copper-colored metal wire w/ transparent surface (on No.43)	Cd	BL	\	\	\	Comply	Jul 22, 2009
		Pb	BL		\	\	Comply	
		Hg	BL		\	\	Comply	
		Cr ⁶⁺	BL		\	\	Comply	
		PBBs	BL		\	\	Comply	
		PBDEs	BL		\	\	Comply	
53	Black plastic part (on No.40)	Cd	BL	\	\	\	Comply	Jul 22, 2009
		Pb	BL		\	\	Comply	
		Hg	BL		\	\	Comply	
		Cr ⁶⁺	BL		\	\	Comply	
		PBBs	BL		\	\	Comply	
		PBDEs	BL		\	\	Comply	
54	Silvery metal sheet (on No.45)	Cd	BL	\	\	\	Comply	Jul 22, 2009
		Pb	BL		\	\	Comply	
		Hg	BL		\	\	Comply	
		Cr ⁶⁺	BL		\	\	Comply	
		PBBs	---		\	\	\	
		PBDEs	---		\	\	\	
55	Grey metal ring (on No.45)	Cd	BL	\	\	\	Comply	Jul 22, 2009
		Pb	BL		\	\	Comply	
		Hg	BL		\	\	Comply	
		Cr ⁶⁺	BL		\	\	Comply	
		PBBs	---		\	\	\	
		PBDEs	---		\	\	\	
56	White adhesive plastic sheet (on No.54)	Cd	BL	\	\	\	Comply	Jul 22, 2009
		Pb	BL		\	\	Comply	
		Hg	BL		\	\	Comply	
		Cr ⁶⁺	BL		\	\	Comply	
		PBBs	---		\	\	Comply	
		PBDEs	BL		\	\	Comply	

This document is issued by the Company under its General Conditions of Service printed overleaf or available on request and accessible at http://www.sgs.com/terms_and_conditions.htm. Attention is drawn to the limitation of liability, indemnification and jurisdiction issues defined therein. Any holder of this document is advised that information contained hereon reflects the Company's findings at the time of its intervention only and within the limits of Client's instructions, if any. The Company's sole responsibility is to its Client and this document does not constitute parties to a transaction from exercising all their rights and obligations under the transaction documents. Any unauthorized alteration, forgery or falsification of the content or appearance of this document is unlawful and offenders may be prosecuted to the fullest extent of the law. Unless otherwise stated, the results shown in this test report refer only to the sample(s) tested. This document cannot be reproduced except in full, without prior approval of the Company.



130 Kazhu Road, Sointech Park, Guangzhou Economic & Technology Development District, Guangzhou, China 510663 | (86-20) 82155555 | (86-20) 82075125 | www.cn.sgs.com
 中国·广州·经济技术开发区科学城科珠路198号 邮编: 510663 | (86-20) 82155555 | (86-20) 82075125 | e sgs.china@sgs.com

Member of the SGS Group (SGS SA)



Verification Report

No.: GZ0907067874/CHEM

Date: NOV 09, 2009

Page 10 of 45

Part No.	Part Name	Restricted Substances	Results of EDXRF ⁽¹⁾	No. of Related Test Report	Results in Related Test Report(mg/kg)	Result of Wet Chemical Testing ⁽²⁾ (mg/kg)	Conclusion on RoHS	Sample Submitted / Resubmitted Date
57	Red plastic (wire insulation) (connected w/ No.54)	Cd	BL	\	\	\	Comply	Jul 22, 2009
		Pb	BL		\	\	Comply	
		Hg	BL		\	\	Comply	
		Cr ⁶⁺	BL		\	\	Comply	
		PBBs	BL		\	\	Comply	
		PBDEs			\	\	Comply	
58	Silvery metal (solder on No.54)	Cd	BL	\	\	\	Comply	Jul 22, 2009
		Pb	BL		\	\	Comply	
		Hg	BL		\	\	Comply	
		Cr ⁶⁺	BL		\	\	Comply	
		PBBs	---		\	\	\	
		PBDEs			\	\	\	
59	White plastic sheet (on No.7)	Cd	BL	\	\	\	Comply	Jul 22, 2009
		Pb	BL		\	\	Comply	
		Hg	BL		\	\	Comply	
		Cr ⁶⁺	BL		\	\	Comply	
		PBBs	BL		\	\	Comply	
		PBDEs			\	\	Comply	
60	Black plastic shell (on No.7)	Cd	BL	\	\	\	Comply	Jul 22, 2009
		Pb	BL		\	\	Comply	
		Hg	BL		\	\	Comply	
		Cr ⁶⁺	BL		\	\	Comply	
		PBBs	IN		\	N.D.	Comply	
		PBDEs			\	N.D.	Comply	
61	Silvery metal pin (in No.7)	Cd	BL	\	\	\	Comply	Jul 22, 2009
		Pb	IN		\	28397 (See remark ^[3])	Comply	
		Hg	BL		\	\	Comply	
		Cr ⁶⁺	BL		\	\	Comply	
		PBBs	---		\	\	\	
		PBDEs			\	\	\	
62	Silvery metal sheet (on No.61)	Cd	BL	\	\	\	Comply	Jul 22, 2009
		Pb	BL		\	\	Comply	
		Hg	BL		\	\	Comply	
		Cr ⁶⁺	BL		\	\	Comply	
		PBBs	---		\	\	\	
		PBDEs			\	\	\	
63	Red plastic ring (on No.62)	Cd	BL	\	\	\	Comply	Jul 22, 2009
		Pb	BL		\	\	Comply	
		Hg	BL		\	\	Comply	
		Cr ⁶⁺	BL		\	\	Comply	
		PBBs	BL		\	\	Comply	
		PBDEs			\	\	Comply	

This document is issued by the Company under its General Conditions of Service printed overleaf or available on request and accessible at http://www.sgs.com/terms_and_conditions.htm. Attention is drawn to the limitation of liability, indemnification and jurisdiction issues defined therein. Any holder of this document is advised that information contained hereon reflects the Company's findings at the time of its intervention only and within the limits of Client's instructions, if any. The Company's sole responsibility is to its Client and this document does not generate parties to a transaction from exercising all their rights and obligations under the transaction documents. Any unauthorized alteration, forgery or falsification of the content or appearance of this document is unlawful and offenders may be prosecuted to the fullest extent of the law. Unless otherwise stated, the results shown in this test report refer only to the sample(s) tested. This document cannot be reproduced except in full, without prior approval of the Company.



130 Kazhu Road, Sointech Park, Guangzhou Economic & Technology Development District, Guangzhou, China 510663 | (86-20) 82155555 | (86-20) 82075125 | www.cn.sgs.com
 中国·广州·经济技术开发区科学城科珠路198号 邮编: 510663 | (86-20) 82155555 | (86-20) 82075125 | e.sgs.china@sgs.com

Member of the SGS Group (SGS SA)



Verification Report

No.: GZ0907067874/CHEM

Date: NOV 09, 2009

Page 11 of 45

Part No.	Part Name	Restricted Substances	Results of EDXRF ⁽¹⁾	No. of Related Test Report	Results in Related Test Report(mg/kg)	Result of Wet Chemical Testing ⁽²⁾ (mg/kg)	Conclusion on RoHS	Sample Submitted / Resubmitted Date
64-C	Lt-blue translucent body (D5 on No.24)	Cd	BL	\	\	\	Comply	Jul 22, 2009/ Aug 26, 2009
		Pb	BL		\	\	Comply	
		Hg	BL		\	\	Comply	
		Cr ⁶⁺	BL		\	\	Comply	
		PBBs	IN		\	N.D.	Comply	
		PBDEs			\	N.D.	Comply	
65	Black body (IR1 on No.24)	Cd	BL	\	\	\	Comply	Jul 22, 2009
		Pb	BL		\	\	Comply	
		Hg	BL		\	\	Comply	
		Cr ⁶⁺	BL		\	\	Comply	
		PBBs	BL		\	\	Comply	
		PBDEs			\	\	Comply	
66	Green "PCB" (big) (in No.2)	Cd	BL	\	\	\	Comply	Jul 22, 2009
		Pb	BL		\	\	Comply	
		Hg	BL		\	\	Comply	
		Cr ⁶⁺	BL		\	\	Comply	
		PBBs	BL		\	\	Comply	
		PBDEs			\	\	Comply	
67	Black body w/ letters (U2 on No.66)	Cd	BL	\	\	\	Comply	Jul 22, 2009
		Pb	BL		\	\	Comply	
		Hg	BL		\	\	Comply	
		Cr ⁶⁺	BL		\	\	Comply	
		PBBs	BL		\	\	Comply	
		PBDEs			\	\	Comply	
68-C	Black body w/ brown printing (U3 on No.66)	Cd	BL	\	\	\	Comply	Jul 22, 2009/ Aug 26, 2009
		Pb	BL		\	\	Comply	
		Hg	BL		\	\	Comply	
		Cr ⁶⁺	BL		\	\	Comply	
		PBBs	IN		\	N.D.	Comply	
		PBDEs			\	N.D.	Comply	
69-C	Black body (Q4 on No.66)	Cd	BL	\	\	\	Comply	Jul 22, 2009/ Aug 26, 2009
		Pb	BL		\	\	Comply	
		Hg	BL		\	\	Comply	
		Cr ⁶⁺	BL		\	\	Comply	
		PBBs	IN		\	N.D.	Comply	
		PBDEs			\	N.D.	Comply	
70	Silvery metal (solder on No.66)	Cd	BL	\	\	\	Comply	Jul 22, 2009
		Pb	BL		\	\	Comply	
		Hg	BL		\	\	Comply	
		Cr ⁶⁺	BL		\	\	Comply	
		PBBs	---		\	\	\	
		PBDEs			\	\	\	

This document is issued by the Company under its General Conditions of Service printed overleaf or available on request and accessible at http://www.sgs.com/terms_and_conditions.htm. Attention is drawn to the limitation of liability, indemnification and jurisdiction issues defined therein. Any holder of this document is advised that information contained hereon reflects the Company's findings at the time of its intervention only and within the limits of Client's instructions, if any. The Company's sole responsibility is to its Client and this document does not constitute part of a transaction from exercising all their rights and obligations under the transaction documents. Any unauthorized alteration, forgery or falsification of the content or appearance of this document is unlawful and offenders may be prosecuted to the fullest extent of the law. Unless otherwise stated, the results shown in this test report refer only to the sample(s) tested. This document cannot be reproduced except in full, without prior approval of the Company.



130 Kazhu Road, Sointech Park, Guangzhou Economic & Technology Development District, Guangzhou, China 510663 | (86-20) 82155555 | (86-20) 82075125 | www.cn.sgs.com
 中国·广州·经济技术开发区科学城科珠路198号 邮编: 510663 | (86-20) 82155555 | (86-20) 82075125 | e sgs.china@sgs.com

Member of the SGS Group (SGS SA)



Verification Report

No.: GZ0907067874/CHEM

Date: NOV 09, 2009

Page 12 of 45

Part No.	Part Name	Restricted Substances	Results of EDXRF ⁽¹⁾	No. of Related Test Report	Results in Related Test Report(mg/kg)	Result of Wet Chemical Testing ⁽²⁾ (mg/kg)	Conclusion on RoHS	Sample Submitted / Resubmitted Date
71	Yellow body w/ brown printing (C16 on No.66)	Cd	BL	\	\	\	Comply	Jul 22, 2009
		Pb	BL		\	\	Comply	
		Hg	BL		\	\	Comply	
		Cr ⁶⁺	BL		\	\	Comply	
		PBBs	BL		\	\	Comply	
		PBDEs			\	\	Comply	
72-C	Black body w/ brown printing (U6 on No.66)	Cd	BL	\	\	\	Comply	Jul 22, 2009/ Aug 26, 2009
		Pb	BL		\	\	Comply	
		Hg	BL		\	\	Comply	
		Cr ⁶⁺	BL		\	\	Comply	
		PBBs	IN		\	N.D.	Comply	
		PBDEs			\	N.D.	Comply	
73	Black body (D2 on No.66)	Cd	BL	\	\	\	Comply	Jul 22, 2009
		Pb	BL		\	\	Comply	
		Hg	BL		\	\	Comply	
		Cr ⁶⁺	BL		\	\	Comply	
		PBBs	BL		\	\	Comply	
		PBDEs			\	\	Comply	
74	Brown "chip capacitor" (C22 on No.66)	Cd	BL	\	\	\	Comply	Jul 22, 2009
		Pb	BL		\	\	Comply	
		Hg	BL		\	\	Comply	
		Cr ⁶⁺	BL		\	\	Comply	
		PBBs	BL		\	\	Comply	
		PBDEs			\	\	Comply	
75	Black body w/ brown printing (U4 on No.66)	Cd	BL	\	\	\	Comply	Jul 22, 2009
		Pb	BL		\	\	Comply	
		Hg	BL		\	\	Comply	
		Cr ⁶⁺	BL		\	\	Comply	
		PBBs	BL		\	\	Comply	
		PBDEs			\	\	Comply	
76-C	Black body w/ brown printing (U1 on No.66)	Cd	BL	\	\	\	Comply	Jul 22, 2009/ Aug 26, 2009
		Pb	BL		\	\	Comply	
		Hg	BL		\	\	Comply	
		Cr ⁶⁺	BL		\	\	Comply	
		PBBs	IN		\	N.D.	Comply	
		PBDEs			\	N.D.	Comply	
77-C	Brown body w/ white printing (F2 on No.66)	Cd	BL	\	\	\	Comply	Jul 22, 2009/ Aug 26, 2009
		Pb	BL		\	\	Comply	
		Hg	BL		\	\	Comply	
		Cr ⁶⁺	BL		\	\	Comply	
		PBBs	IN		\	N.D.	Comply	
		PBDEs			\	N.D.	Comply	

This document is issued by the Company under its General Conditions of Service printed overleaf or available on request and accessible at http://www.sgs.com/terms_and_conditions.htm. Attention is drawn to the limitation of liability, indemnification and jurisdiction issues defined therein. Any holder of this document is advised that information contained hereon reflects the Company's findings at the time of its intervention only and within the limits of Client's instructions, if any. The Company's sole responsibility is to its Client and this document does not constitute parties to a transaction from exercising all their rights and obligations under the transaction documents. Any unauthorized alteration, forgery or falsification of the content or appearance of this document is unlawful and offenders may be prosecuted to the fullest extent of the law. Unless otherwise stated, the results shown in this test report refer only to the sample(s) tested. This document cannot be reproduced except in full, without prior approval of the Company.



130 Kazhu Road, Sointech Park, Guangzhou Economic & Technology Development District, Guangzhou, China 510663 | (86-20) 82155555 | (86-20) 82075125 | www.cn.sgs.com
 中国·广州·经济技术开发区科学城科珠路198号 邮编: 510663 | (86-20) 82155555 | (86-20) 82075125 | e sgs.china@sgs.com

Member of the SGS Group (SGS SA)



Verification Report

No.: GZ0907067874/CHEM

Date: NOV 09, 2009

Page 13 of 45

Part No.	Part Name	Restricted Substances	Results of EDXRF ⁽¹⁾	No. of Related Test Report	Results in Related Test Report(mg/kg)	Result of Wet Chemical Testing ⁽²⁾ (mg/kg)	Conclusion on RoHS	Sample Submitted / Resubmitted Date
78-C	Black body w/ brown printing (D1 on No.66)	Cd	BL	\	\	\	Comply	Jul 22, 2009/ Aug 26, 2009
		Pb	BL		\	\	Comply	
		Hg	BL		\	\	Comply	
		Cr ⁶⁺	BL		\	\	Comply	
		PBBs	IN		\	N.D.	Comply	
		PBDEs			\	N.D.	Comply	
79	White plastic (housing) (on No.66)	Cd	BL	\	\	\	Comply	Jul 22, 2009
		Pb	BL		\	\	Comply	
		Hg	BL		\	\	Comply	
		Cr ⁶⁺	BL		\	\	Comply	
		PBBs	BL		\	\	Comply	
		PBDEs			\	\	Comply	
80	Black plastic sheet (base) (C3 on No.66)	Cd	BL	\	\	\	Comply	Jul 22, 2009
		Pb	BL		\	\	Comply	
		Hg	BL		\	\	Comply	
		Cr ⁶⁺	BL		\	\	Comply	
		PBBs	BL		\	\	Comply	
		PBDEs			\	\	Comply	
81-C	Black body w/ brown printing (D4 on No.66)	Cd	BL	\	\	\	Comply	Jul 22, 2009/ Aug 26, 2009
		Pb	BL		\	\	Comply	
		Hg	BL		\	\	Comply	
		Cr ⁶⁺	BL		\	\	Comply	
		PBBs	IN		\	N.D.	Comply	
		PBDEs			\	N.D.	Comply	
82-C	Black body w/ brown printing (Q2 on No.66)	Cd	BL	\	\	\	Comply	Jul 22, 2009/ Aug 26, 2009
		Pb	BL		\	\	Comply	
		Hg	BL		\	\	Comply	
		Cr ⁶⁺	BL		\	\	Comply	
		PBBs	IN		\	N.D.	Comply	
		PBDEs			\	N.D.	Comply	
83	Silvery body (H1 on No.66)	Cd	BL	\	\	\	Comply	Jul 22, 2009
		Pb	BL		\	\	Comply	
		Hg	BL		\	\	Comply	
		Cr ⁶⁺	BL		\	\	Comply	
		PBBs	BL		\	\	Comply	
		PBDEs			\	\	Comply	
84-C	Black plastic shell (BL1 on No.66)	Cd	BL	\	\	\	Comply	Jul 22, 2009/ Sep 29, 2009
		Pb	BL		\	\	Comply	
		Hg	BL		\	\	Comply	
		Cr ⁶⁺	BL		\	\	Comply	
		PBBs	IN		\	N.D.	Comply	
		PBDEs			\	Mono-Octa: N.D. Nona:13, Deca:12	Comply	

This document is issued by the Company under its General Conditions of Service printed overleaf or available on request and accessible at http://www.sgs.com/terms_and_conditions.htm. Attention is drawn to the limitation of liability, indemnification and jurisdiction issues defined therein. Any holder of this document is advised that information contained hereon reflects the Company's findings at the time of its intervention only and within the limits of Client's instructions, if any. The Company's sole responsibility is to its Client and this document does not generate parties to a transaction from exercising all their rights and obligations under the transaction documents. Any unauthorized alteration, forgery or falsification of the content or appearance of this document is unlawful and offenders may be prosecuted to the fullest extent of the law. Unless otherwise stated, the results shown in this test report refer only to the sample(s) tested. This document cannot be reproduced except in full, without prior approval of the Company.



130 Kazhu Road, Sointech Park Guangzhou Economic & Technology Development District, Guangzhou, China 510663 | (86-20) 82155555 | (86-20) 82075125 | www.cn.sgs.com
 中国·广州·经济技术开发区科学城科珠路198号 邮编: 510663 | (86-20) 82155555 | (86-20) 82075125 | e.sgs.china@sgs.com

Member of the SGS Group (SGS SA)



Verification Report

No.: GZ0907067874/CHEM

Date: NOV 09, 2009

Page 14 of 45

Part No.	Part Name	Restricted Substances	Results of EDXRF ⁽¹⁾	No. of Related Test Report	Results in Related Test Report(mg/kg)	Result of Wet Chemical Testing ⁽²⁾ (mg/kg)	Conclusion on RoHS	Sample Submitted / Resubmitted Date
85-C	Black plastic shell (on No.66)	Cd	BL	\	\	\	Comply	Jul 22, 2009/ Sep 29, 2009
		Pb	BL		\	\	Comply	
		Hg	BL		\	\	Comply	
		Cr ⁶⁺	BL		\	\	Comply	
		PBBs	IN		\	N.D.	Comply	
		PBDEs			\	Mono-Octa: N.D. Nona:14, Deca:131	Comply	
86-C	Golden metal pin (in No.85)	Cd	BL	\	\	\	Comply	Jul 22, 2009/ Aug 26, 2009
		Pb	BL		\	\	Comply	
		Hg	BL		\	\	Comply	
		Cr ⁶⁺	BL		\	\	Comply	
		PBBs	---		\	\	\	
		PBDEs	---		\	\	\	
87	Silvery metal sheet (in No.79)	Cd	BL	\	\	\	Comply	Jul 22, 2009
		Pb	BL		\	\	Comply	
		Hg	BL		\	\	Comply	
		Cr ⁶⁺	BL		\	\	Comply	
		PBBs	---		\	\	\	
		PBDEs	---		\	\	\	
88	Silvery metal pin (in No.79)	Cd	BL	\	\	\	Comply	Jul 22, 2009
		Pb	BL		\	\	Comply	
		Hg	BL		\	\	Comply	
		Cr ⁶⁺	BL		\	\	Comply	
		PBBs	---		\	\	\	
		PBDEs	---		\	\	\	
89	White plastic (socket) (connected w/ No.79)	Cd	BL	\	\	\	Comply	Jul 22, 2009
		Pb	BL		\	\	Comply	
		Hg	BL		\	\	Comply	
		Cr ⁶⁺	BL		\	\	Comply	
		PBBs	BL		\	\	Comply	
		PBDEs	---		\	\	Comply	
90	Silvery metal terminal (in No.89)	Cd	BL	\	\	\	Comply	Jul 22, 2009
		Pb	BL		\	\	Comply	
		Hg	BL		\	\	Comply	
		Cr ⁶⁺	BL		\	\	Comply	
		PBBs	---		\	\	\	
		PBDEs	---		\	\	\	
91	Silvery metal shell w/ black printing (on No.80)	Cd	BL	\	\	\	Comply	Jul 22, 2009
		Pb	BL		\	\	Comply	
		Hg	BL		\	\	Comply	
		Cr ⁶⁺	BL		\	\	Comply	
		PBBs	---		\	\	\	
		PBDEs	---		\	\	\	

This document is issued by the Company under its General Conditions of Service printed overleaf or available on request and accessible at http://www.sgs.com/terms_and_conditions.htm. Attention is drawn to the limitation of liability, indemnification and jurisdiction issues defined therein. Any holder of this document is advised that information contained hereon reflects the Company's findings at the time of its intervention only and within the limits of Client's instructions, if any. The Company's sole responsibility is to its Client and this document does not generate parties to a transaction from exercising all their rights and obligations under the transaction documents. Any unauthorized alteration, forgery or falsification of the content or appearance of this document is unlawful and offenders may be prosecuted to the fullest extent of the law. Unless otherwise stated, the results shown in this test report refer only to the sample(s) tested. This document cannot be reproduced except in full, without prior approval of the Company.



130 Kazhu Road, Sointech Park, Guangzhou Economic & Technology Development District, Guangzhou, China 510663 | (86-20) 82155555 | (86-20) 82075125 | www.cn.sgs.com
 中国·广州·经济技术开发区科学城科珠路198号 邮编: 510663 | (86-20) 82155555 | (86-20) 82075125 | e.sgs.china@sgs.com

Member of the SGS Group (SGS SA)



Verification Report

No.: GZ0907067874/CHEM

Date: NOV 09, 2009

Page 15 of 45

Part No.	Part Name	Restricted Substances	Results of EDXRF ⁽¹⁾	No. of Related Test Report	Results in Related Test Report(mg/kg)	Result of Wet Chemical Testing ⁽²⁾ (mg/kg)	Conclusion on RoHS	Sample Submitted / Resubmitted Date
92	Lt-brown paper w/ liquid (in No.91)	Cd	BL	\	\	\	Comply	Jul 22, 2009
		Pb	BL		\	\	Comply	
		Hg	BL		\	\	Comply	
		Cr ⁶⁺	BL		\	\	Comply	
		PBBs	BL		\	\	Comply	
		PBDEs			\	\	Comply	
93	Grey metal foil (in No.91)	Cd	BL	\	\	\	Comply	Jul 22, 2009
		Pb	BL		\	\	Comply	
		Hg	BL		\	\	Comply	
		Cr ⁶⁺	BL		\	\	Comply	
		PBBs	---		\	\	\	
		PBDEs			\	\	\	
94	Black rubber (cover) (on No.91)	Cd	BL	\	\	\	Comply	Jul 22, 2009
		Pb	BL		\	\	Comply	
		Hg	BL		\	\	Comply	
		Cr ⁶⁺	BL		\	\	Comply	
		PBBs	BL		\	\	Comply	
		PBDEs			\	\	Comply	
95	Silvery metal pin (in No.91)	Cd	BL	\	\	\	Comply	Jul 22, 2009
		Pb	BL		\	\	Comply	
		Hg	BL		\	\	Comply	
		Cr ⁶⁺	BL		\	\	Comply	
		PBBs	---		\	\	\	
		PBDEs			\	\	\	
96	White adhesive plastic shell w/ purple printing (on No.84)	Cd	BL	\	\	\	Comply	Jul 22, 2009
		Pb	BL		\	\	Comply	
		Hg	BL		\	\	Comply	
		Cr ⁶⁺	BL		\	\	Comply	
		PBBs	BL		\	\	Comply	
		PBDEs			\	\	Comply	
97	Dk-grey core (in No.84)	Cd	BL	\	\	\	Comply	Jul 22, 2009
		Pb	BL		\	\	Comply	
		Hg	BL		\	\	Comply	
		Cr ⁶⁺	BL		\	\	Comply	
		PBBs	BL		\	\	Comply	
		PBDEs			\	\	Comply	
98	Silvery metal sheet (on No.97)	Cd	BL	\	\	\	Comply	Jul 22, 2009
		Pb	BL		\	\	Comply	
		Hg	BL		\	\	Comply	
		Cr ⁶⁺	BL		\	\	Comply	
		PBBs	---		\	\	\	
		PBDEs			\	\	\	

This document is issued by the Company under its General Conditions of Service printed overleaf or available on request and accessible at http://www.sgs.com/terms_and_conditions.htm. Attention is drawn to the limitation of liability, indemnification and jurisdiction issues defined therein. Any holder of this document is advised that information contained hereon reflects the Company's findings at the time of its intervention only and within the limits of Client's instructions, if any. The Company's sole responsibility is to its Client and this document does not operate parties to a transaction from exercising all their rights and obligations under the transaction documents. Any unauthorized alteration, forgery or falsification of the content or appearance of this document is unlawful and offenders may be prosecuted to the fullest extent of the law. Unless otherwise stated the results shown in this test report refer only to the sample(s) tested. This document cannot be reproduced except in full, without prior approval of the Company.





Verification Report

No.: GZ0907067874/CHEM

Date: NOV 09, 2009

Page 16 of 45

Part No.	Part Name	Restricted Substances	Results of EDXRF ⁽¹⁾	No. of Related Test Report	Results in Related Test Report(mg/kg)	Result of Wet Chemical Testing ⁽²⁾ (mg/kg)	Conclusion on RoHS	Sample Submitted / Resubmitted Date
99	Silvery metal shaft (in No.97)	Cd	BL	\	\	\	Comply	Jul 22, 2009
		Pb	BL		\	\	Comply	
		Hg	BL		\	\	Comply	
		Cr ⁶⁺	BL		\	\	Comply	
		PBBs	---		\	\	\	
		PBDEs	---		\	\	\	
100	Copper-colored metal wire w/ blue surface (on No.99)	Cd	BL	\	\	\	Comply	Jul 22, 2009
		Pb	BL		\	\	Comply	
		Hg	BL		\	\	Comply	
		Cr ⁶⁺	BL		\	\	Comply	
		PBBs	BL		\	\	Comply	
		PBDEs	BL		\	\	Comply	
101	Silvery metal sheet (on No.99)	Cd	BL	\	\	\	Comply	Jul 22, 2009
		Pb	BL		\	\	Comply	
		Hg	BL		\	\	Comply	
		Cr ⁶⁺	BL		\	\	Comply	
		PBBs	---		\	\	\	
		PBDEs	---		\	\	\	
102	White glue (on No.101)	Cd	BL	\	\	\	Comply	Jul 22, 2009
		Pb	BL		\	\	Comply	
		Hg	BL		\	\	Comply	
		Cr ⁶⁺	BL		\	\	Comply	
		PBBs	BL		\	\	Comply	
		PBDEs	BL		\	\	Comply	
103-C	Black body w/ brown printing (D1 on No.66)	Cd	BL	\	\	\	Comply	Jul 22, 2009/ Aug 26, 2009
		Pb	BL		\	\	Comply	
		Hg	BL		\	\	Comply	
		Cr ⁶⁺	BL		\	\	Comply	
		PBBs	IN		\	N.D.	Comply	
		PBDEs	IN		\	N.D.	Comply	
104	Black body w/ brown printing (U5 on No.66)	Cd	BL	\	\	\	Comply	Jul 22, 2009
		Pb	BL		\	\	Comply	
		Hg	BL		\	\	Comply	
		Cr ⁶⁺	BL		\	\	Comply	
		PBBs	BL		\	\	Comply	
		PBDEs	BL		\	\	Comply	
105-C	Black plastic (switch base) (K1 on No.66)	Cd	BL	\	\	\	Comply	Jul 22, 2009/ Aug 26, 2009
		Pb	BL		\	\	Comply	
		Hg	BL		\	\	Comply	
		Cr ⁶⁺	BL		\	\	Comply	
		PBBs	IN		\	N.D.	Comply	
		PBDEs	IN		\	N.D.	Comply	

This document is issued by the Company under its General Conditions of Service printed overleaf or available on request and accessible at http://www.sgs.com/terms_and_conditions.htm. Attention is drawn to the limitation of liability, indemnification and jurisdiction issues defined therein. Any holder of this document is advised that information contained hereon reflects the Company's findings at the time of its intervention only and within the limits of Client's instructions, if any. The Company's sole responsibility is to its Client and this document does not constitute parties to a transaction from exercising all their rights and obligations under the transaction documents. Any unauthorized alteration, forgery or falsification of the content or appearance of this document is unlawful and offenders may be prosecuted to the fullest extent of the law. Unless otherwise stated, the results shown in this test report refer only to the sample(s) tested. This document cannot be reproduced except in full, without prior approval of the Company.



130 Kazhu Road, Sointech Park Guangzhou Economic & Technology Development District, Guangzhou, China 510663 | (86-20) 82155555 | (86-20) 82075125 | www.cn.sgs.com
 中国·广州·经济技术开发区科学城科珠路198号 邮编: 510663 | (86-20) 82155555 | (86-20) 82075125 | e sgs.china@sgs.com

Member of the SGS Group (SGS SA)



Verification Report

No.: GZ0907067874/CHEM

Date: NOV 09, 2009

Page 17 of 45

Part No.	Part Name	Restricted Substances	Results of EDXRF ⁽¹⁾	No. of Related Test Report	Results in Related Test Report(mg/kg)	Result of Wet Chemical Testing ⁽²⁾ (mg/kg)	Conclusion on RoHS	Sample Submitted / Resubmitted Date
106	Silvery metal sheet (on No.105)	Cd	BL	\	\	\	Comply	Jul 22, 2009
		Pb	BL		\	\	Comply	
		Hg	BL		\	\	Comply	
		Cr ⁶⁺	BL		\	\	Comply	
		PBBs	---		\	\	\	
		PBDEs	---		\	\	\	
107	Black plastic shell (S1 on No.66)	Cd	BL	\	\	\	Comply	Jul 22, 2009
		Pb	BL		\	\	Comply	
		Hg	BL		\	\	Comply	
		Cr ⁶⁺	BL		\	\	Comply	
		PBBs	BL		\	\	Comply	
		PBDEs	---		\	\	Comply	
108	Silvery metal pin (in No.105)	Cd	BL	\	\	\	Comply	Jul 22, 2009
		Pb	BL		\	\	Comply	
		Hg	BL		\	\	Comply	
		Cr ⁶⁺	BL		\	\	Comply	
		PBBs	---		\	\	\	
		PBDEs	---		\	\	\	
109	Silvery metal sheet (in No.105)	Cd	BL	\	\	\	Comply	Jul 22, 2009
		Pb	BL		\	\	Comply	
		Hg	BL		\	\	Comply	
		Cr ⁶⁺	BL		\	\	Comply	
		PBBs	---		\	\	\	
		PBDEs	---		\	\	\	
110-C	Black plastic button (on No.105)	Cd	BL	\	\	\	Comply	Jul 22, 2009/ Aug 26, 2009
		Pb	BL		\	\	Comply	
		Hg	BL		\	\	Comply	
		Cr ⁶⁺	BL		\	\	Comply	
		PBBs	---		\	N.D.	Comply	
		PBDEs	IN		\	Mono-Octa: N.D. Nona:32, Deca:678	Comply	
111	Translucent rubber cap (on No.110)	Cd	BL	\	\	\	Comply	Jul 22, 2009
		Pb	BL		\	\	Comply	
		Hg	BL		\	\	Comply	
		Cr ⁶⁺	BL		\	\	Comply	
		PBBs	BL		\	\	Comply	
		PBDEs	---		\	\	Comply	
112	Golden metal pin (in No.107)	Cd	BL	\	\	\	Comply	Jul 22, 2009
		Pb	BL		\	\	Comply	
		Hg	BL		\	\	Comply	
		Cr ⁶⁺	BL		\	\	Comply	
		PBBs	---		\	\	\	
		PBDEs	---		\	\	\	

This document is issued by the Company under its General Conditions of Service printed overleaf or available on request and accessible at http://www.sgs.com/terms_and_conditions.htm. Attention is drawn to the limitation of liability, indemnification and jurisdiction issues defined therein. Any holder of this document is advised that information contained hereon reflects the Company's findings at the time of its intervention only and within the limits of Client's instructions, if any. The Company's sole responsibility is to its Client and this document does not generate parties to a transaction from exercising all their rights and obligations under the transaction documents. Any unauthorized alteration, forgery or falsification of the content or appearance of this document is unlawful and offenders may be prosecuted to the fullest extent of the law. Unless otherwise stated, the results shown in this test report refer only to the sample(s) tested. This document cannot be reproduced except in full, without prior approval of the Company.





Verification Report

No.: GZ0907067874/CHEM

Date: NOV 09, 2009

Page 18 of 45

Part No.	Part Name	Restricted Substances	Results of EDXRF ⁽¹⁾	No. of Related Test Report	Results in Related Test Report(mg/kg)	Result of Wet Chemical Testing ⁽²⁾ (mg/kg)	Conclusion on RoHS	Sample Submitted / Resubmitted Date
113	Golden metal bead (in No.107)	Cd	BL	\	\	\	Comply	Jul 22, 2009
		Pb	BL		\	\	Comply	
		Hg	BL		\	\	Comply	
		Cr ⁶⁺	BL		\	\	Comply	
		PBBs	---		\	\	\	
		PBDEs	---		\	\	\	
114	Silvery metal pin (connected w/ No.66)	Cd	BL	\	\	\	Comply	Jul 22, 2009
		Pb	BL		\	\	Comply	
		Hg	BL		\	\	Comply	
		Cr ⁶⁺	BL		\	\	Comply	
		PBBs	---		\	\	\	
		PBDEs	---		\	\	\	
115	Transparent glass sheet w/ liquid (LCD) (connected w/ No.114)	Cd	BL	\	\	\	Comply	Jul 22, 2009
		Pb	BL		\	\	Comply	
		Hg	BL		\	\	Comply	
		Cr ⁶⁺	BL		\	\	Comply	
		PBBs	BL		\	\	Comply	
		PBDEs	BL		\	\	Comply	
116	Dk-grey transparent double-side adhesive plastic sheet (on No.115)	Cd	BL	\	\	\	Comply	Jul 22, 2009
		Pb	BL		\	\	Comply	
		Hg	BL		\	\	Comply	
		Cr ⁶⁺	BL		\	\	Comply	
		PBBs	BL		\	\	Comply	
		PBDEs	BL		\	\	Comply	
117	Dk-grey transparent adhesive plastic sheet (on No.115)	Cd	BL	\	\	\	Comply	Jul 22, 2009
		Pb	BL		\	\	Comply	
		Hg	BL		\	\	Comply	
		Cr ⁶⁺	BL		\	\	Comply	
		PBBs	BL		\	\	Comply	
		PBDEs	BL		\	\	Comply	
118	Silvery plastic film (on No.116)	Cd	BL	\	\	\	Comply	Jul 22, 2009
		Pb	BL		\	\	Comply	
		Hg	BL		\	\	Comply	
		Cr ⁶⁺	BL		\	\	Comply	
		PBBs	BL		\	\	Comply	
		PBDEs	BL		\	\	Comply	
119	Green "PCB" (on No.66)	Cd	BL	\	\	\	Comply	Jul 22, 2009
		Pb	BL		\	\	Comply	
		Hg	BL		\	\	Comply	
		Cr ⁶⁺	BL		\	\	Comply	
		PBBs	IN		\	N.D.	Comply	
		PBDEs	IN		\	N.D.	Comply	

This document is issued by the Company under its General Conditions of Service printed overleaf or available on request and accessible at http://www.sgs.com/terms_and_conditions.htm. Attention is drawn to the limitation of liability, indemnification and jurisdiction issues defined therein. Any holder of this document is advised that information contained hereon reflects the Company's findings at the time of its intervention only and within the limits of Client's instructions, if any. The Company's sole responsibility is to its Client and this document does not constitute parties to a transaction from exercising all their rights and obligations under the transaction documents. Any unauthorized alteration, forgery or falsification of the content or appearance of this document is unlawful and offenders may be prosecuted to the fullest extent of the law. Unless otherwise stated, the results shown in this test report refer only to the sample(s) tested. This document cannot be reproduced except in full, without prior approval of the Company.



130 Kazhu Road, Sointech Park, Guangzhou Economic & Technology Development District, Guangzhou, China 510663 | (86-20) 82155555 | (86-20) 82075125 | www.cn.sgs.com
 中国·广州·经济技术开发区科学城科珠路198号 邮编: 510663 | (86-20) 82155555 | (86-20) 82075125 | e.sgs.china@sgs.com

Member of the SGS Group (SGS SA)



Verification Report

No.: GZ0907067874/CHEM

Date: NOV 09, 2009

Page 19 of 45

Part No.	Part Name	Restricted Substances	Results of EDXRF ⁽¹⁾	No. of Related Test Report	Results in Related Test Report(mg/kg)	Result of Wet Chemical Testing ⁽²⁾ (mg/kg)	Conclusion on RoHS	Sample Submitted / Resubmitted Date
120-C	Black body w/ brown printing (U3 on No.119)	Cd	BL	\	\	\	Comply	Jul 22, 2009/ Aug 26, 2009
		Pb	BL		\	\	Comply	
		Hg	BL		\	\	Comply	
		Cr ⁶⁺	BL		\	\	Comply	
		PBBs	IN		\	N.D.	Comply	
		PBDEs			\	N.D.	Comply	
121	Black body w/ brown printing (U1 on No.119)	Cd	BL	\	\	\	Comply	Jul 22, 2009
		Pb	BL		\	\	Comply	
		Hg	BL		\	\	Comply	
		Cr ⁶⁺	BL		\	\	Comply	
		PBBs	BL		\	\	Comply	
		PBDEs			\	\	Comply	
122	Multicolor adhesive plastic sheet w/ black printing (label on No.121)	Cd	BL	\	\	\	Comply	Jul 22, 2009
		Pb	BL		\	\	Comply	
		Hg	BL		\	\	Comply	
		Cr ⁶⁺	BL		\	\	Comply	
		PBBs	BL		\	\	Comply	
		PBDEs			\	\	Comply	
123-C	Black body w/ white printing (RP1 on No.119)	Cd	BL	\	\	\	Comply	Jul 22, 2009/ Aug 26, 2009/ Sep 29, 2009/ Oct 26, 2009
		Pb	See remark ^[4]		\	\	Comply	
		Hg	BL		\	\	Comply	
		Cr ⁶⁺	BL		\	\	Comply	
		PBBs	BL		\	\	Comply	
		PBDEs			\	\	Comply	
124	Silvery body (Y1 on No.119)	Cd	BL	\	\	\	Comply	Jul 22, 2009
		Pb	BL		\	\	Comply	
		Hg	BL		\	\	Comply	
		Cr ⁶⁺	BL		\	\	Comply	
		PBBs	BL		\	\	Comply	
		PBDEs			\	\	Comply	
125-C	Grey "chip capacitor" (C6 on No.119)	Cd	BL	\	\	\	Comply	Jul 22, 2009/ Sep 29, 2009/ Oct 26, 2009
		Pb	BL		\	\	Comply	
		Hg	BL		\	\	Comply	
		Cr ⁶⁺	BL		\	\	Comply	
		PBBs	BL		\	\	Comply	
		PBDEs			\	\	Comply	
126	Black plastic part (J1 on No.119)	Cd	BL	\	\	\	Comply	Jul 22, 2009
		Pb	BL		\	\	Comply	
		Hg	BL		\	\	Comply	
		Cr ⁶⁺	BL		\	\	Comply	
		PBBs	BL		\	\	Comply	
		PBDEs			\	\	Comply	

This document is issued by the Company under its General Conditions of Service printed overleaf or available on request and accessible at http://www.sgs.com/terms_and_conditions.htm. Attention is drawn to the limitation of liability, indemnification and jurisdiction issues defined therein. Any holder of this document is advised that information contained hereon reflects the Company's findings at the time of its intervention only and within the limits of Client's instructions, if any. The Company's sole responsibility is to its Client and this document does not generate parties to a transaction from exercising all their rights and obligations under the transaction documents. Any unauthorized alteration, forgery or falsification of the content or appearance of this document is unlawful and offenders may be prosecuted to the fullest extent of the law. Unless otherwise stated, the results shown in this test report refer only to the sample(s) tested. This document cannot be reproduced except in full, without prior approval of the Company.



130 Kazhu Road, Sointech Park, Guangzhou Economic & Technology Development District, Guangzhou, China 510663 | (86-20) 82155555 | (86-20) 82075125 | www.cn.sgs.com
 中国·广州·经济技术开发区科学城科珠路198号 邮编: 510663 | (86-20) 82155555 | (86-20) 82075125 | e.sgs.china@sgs.com

Member of the SGS Group (SGS SA)

Part No.	Part Name	Restricted Substances	Results of EDXRF ⁽¹⁾	No. of Related Test Report	Results in Related Test Report(mg/kg)	Result of Wet Chemical Testing ⁽²⁾ (mg/kg)	Conclusion on RoHS	Sample Submitted / Resubmitted Date
127	Silvery metal pin (on No.126)	Cd	BL	\	\	\	Comply	Jul 22, 2009
		Pb	BL		\	\	Comply	
		Hg	BL		\	\	Comply	
		Cr ⁶⁺	BL		\	\	Comply	
		PBBs	---		\	\	Comply	
		PBDEs	---		\	\	Comply	
128-C	Brown "chip capacitor" (C1 on No.119)	Cd	BL	\	\	\	Comply	Jul 22, 2009/ Aug 26, 2009
		Pb	BL		\	\	Comply	
		Hg	BL		\	\	Comply	
		Cr ⁶⁺	BL		\	\	Comply	
		PBBs	BL		\	\	Comply	
		PBDEs	BL		\	\	Comply	
129-C	Black "chip resistor" (R5 on No.119)	Cd	BL	\	\	\	Comply	Jul 22, 2009/ Aug 26, 2009
		Pb	See remark ⁽⁵⁾		\	\	Comply	
		Hg	BL		\	\	Comply	
		Cr ⁶⁺	BL		\	\	Comply	
		PBBs	BL		\	\	Comply	
		PBDEs	BL		\	\	Comply	
130	Black body w/ brown printing (U2 on No.119)	Cd	BL	\	\	\	Comply	Jul 22, 2009
		Pb	BL		\	\	Comply	
		Hg	BL		\	\	Comply	
		Cr ⁶⁺	BL		\	\	Comply	
		PBBs	BL		\	\	Comply	
		PBDEs	BL		\	\	Comply	
131	Black adhesive fiber sheet (on No.130)	Cd	BL	\	\	\	Comply	Jul 22, 2009
		Pb	BL		\	\	Comply	
		Hg	BL		\	\	Comply	
		Cr ⁶⁺	BL		\	\	Comply	
		PBBs	BL		\	\	Comply	
		PBDEs	BL		\	\	Comply	
132	Silvery body (crystal oscillator) (Y2 on No.119)	Cd	BL	\	\	\	Comply	Jul 22, 2009
		Pb	BL		\	\	Comply	
		Hg	BL		\	\	Comply	
		Cr ⁶⁺	BL		\	\	Comply	
		PBBs	BL		\	\	Comply	
		PBDEs	BL		\	\	Comply	
133	Black plastic shell (B1 on No.119)	Cd	BL	\	\	\	Comply	Jul 22, 2009
		Pb	BL		\	\	Comply	
		Hg	BL		\	\	Comply	
		Cr ⁶⁺	BL		\	\	Comply	
		PBBs	IN		\	N.D.	Comply	
		PBDEs	IN		\	Mono-Octa: N.D. Nona:27, Deca:356	Comply	

This document is issued by the Company under its General Conditions of Service printed overleaf or available on request and accessible at http://www.sgs.com/terms_and_conditions.htm. Attention is drawn to the limitation of liability, indemnification and jurisdiction issues defined therein. Any holder of this document is advised that information contained hereon reflects the Company's findings at the time of its intervention only and within the limits of Client's instructions, if any. The Company's sole responsibility is to its Client and this document does not generate parties to a transaction from exercising all their rights and obligations under the transaction documents. Any unauthorized alteration, forgery or falsification of the content or appearance of this document is unlawful and offenders may be prosecuted to the fullest extent of the law.

Unless otherwise stated, the results shown in this test report refer only to the sample(s) tested. This document cannot be reproduced except in full, without prior approval of the Company.





Verification Report

No.: GZ0907067874/CHEM

Date: NOV 09, 2009

Page 21 of 45

Part No.	Part Name	Restricted Substances	Results of EDXRF ⁽¹⁾	No. of Related Test Report	Results in Related Test Report(mg/kg)	Result of Wet Chemical Testing ⁽²⁾ (mg/kg)	Conclusion on RoHS	Sample Submitted / Resubmitted Date
134	Silvery metal sheet (on No.133)	Cd	BL	\	\	\	Comply	Jul 22, 2009
		Pb	BL		\	\	Comply	
		Hg	BL		\	\	Comply	
		Cr ⁶⁺	BL		\	\	Comply	
		PBBs	---		\	\	\	
		PBDEs	---		\	\	\	
135	Red surfaced metal wire (connected w/ No.119)	Cd	BL	\	\	\	Comply	Jul 22, 2009
		Pb	BL		\	\	Comply	
		Hg	BL		\	\	Comply	
		Cr ⁶⁺	BL		\	\	Comply	
		PBBs	BL		\	\	Comply	
		PBDEs	BL		\	\	Comply	
136	Beige paper sheet (on No.2)	Cd	BL	\	\	\	Comply	Jul 22, 2009
		Pb	BL		\	\	Comply	
		Hg	BL		\	\	Comply	
		Cr ⁶⁺	BL		\	\	Comply	
		PBBs	BL		\	\	Comply	
		PBDEs	BL		\	\	Comply	
137	Transparent adhesive plastic sheet w/ white surface & multicolor printing (on No.2)	Cd	BL	\	\	\	Comply	Jul 22, 2009
		Pb	BL		\	\	Comply	
		Hg	BL		\	\	Comply	
		Cr ⁶⁺	BL		\	\	Comply	
		PBBs	BL		\	\	Comply	
		PBDEs	BL		\	\	Comply	
138	Transparent plastic film (on No.137)	Cd	BL	\	\	\	Comply	Jul 22, 2009
		Pb	BL		\	\	Comply	
		Hg	BL		\	\	Comply	
		Cr ⁶⁺	BL		\	\	Comply	
		PBBs	BL		\	\	Comply	
		PBDEs	BL		\	\	Comply	
141-C	Silvery metal (solder on No.119)	Cd	IN	\	\	N.D.	Comply	Jul 22, 2009/ Sep 29, 2009
		Pb	BL		\	\	Comply	
		Hg	BL		\	\	Comply	
		Cr ⁶⁺	BL		\	\	Comply	
		PBBs	---		\	\	\	
		PBDEs	---		\	\	\	
140	White plastic shell	Cd	BL	\	\	\	Comply	Jul 22, 2009
		Pb	BL		\	\	Comply	
		Hg	BL		\	\	Comply	
		Cr ⁶⁺	BL		\	\	Comply	
		PBBs	BL		\	\	Comply	
		PBDEs	BL		\	\	Comply	

This document is issued by the Company under its General Conditions of Service printed overleaf or available on request and accessible at http://www.sgs.com/terms_and_conditions.htm. Attention is drawn to the limitation of liability, indemnification and jurisdiction issues defined therein. Any holder of this document is advised that information contained hereon reflects the Company's findings at the time of its intervention only and within the limits of Client's instructions, if any. The Company's sole responsibility is to its Client and this document does not generate parties to a transaction from exercising all their rights and obligations under the transaction documents. Any unauthorized alteration, forgery or falsification of the content or appearance of this document is unlawful and offenders may be prosecuted to the fullest extent of the law. Unless otherwise stated, the results shown in this test report refer only to the sample(s) tested. This document cannot be reproduced except in full, without prior approval of the Company.



130 Kazhu Road, Sointech Park Guangzhou Economic & Technology Development District, Guangzhou, China 510663 | (86-20) 82155555 | (86-20) 82075125 | www.cn.sgs.com
 中国·广州·经济技术开发区科学城科珠路198号 邮编: 510663 | (86-20) 82155555 | (86-20) 82075125 | e.sgs.china@sgs.com

Member of the SGS Group (SGS SA)

Part No.	Part Name	Restricted Substances	Results of EDXRF ⁽¹⁾	No. of Related Test Report	Results in Related Test Report(mg/kg)	Result of Wet Chemical Testing ⁽²⁾ (mg/kg)	Conclusion on RoHS	Sample Submitted / Resubmitted Date
141	Yellow plastic shell	Cd	BL	\	\	\	Comply	Jul 22, 2009
		Pb	BL		\	\	Comply	
		Hg	BL		\	\	Comply	
		Cr ⁶⁺	BL		\	\	Comply	
		PBBs	BL		\	\	Comply	
		PBDEs			\	\	Comply	

Remark

- (1) (a) It is the result on total Br while test item on restricted substances is PBBs/PBDEs. It is the result on total Cr while test item on restricted substances is Cr⁶⁺.
- (b) Results are obtained by EDXRF for primary screening, and further chemical testing by ICP (for Cd, Pb, Hg), UV-VIS (for CrVI) and GCMSD (for PBBs, PBDEs) is recommended to be performed, if the concentration exceeds the below warning value according to IEC 62321:2008 (unit: mg/kg)

Element	Polymer	Metal	Composite Materials
Cd	BL ≤ (700-3σ) < X < (1300+3σ) ≤ OL	BL ≤ (700-3σ) < X < (1300+3σ) ≤ OL	LOD < X < (150+3σ) ≤ OL
Pb	BL ≤ (700-3σ) < X < (1300+3σ) ≤ OL	BL ≤ (700-3σ) < X < (1300+3σ) ≤ OL	BL ≤ (500-3σ) < X < (1500+3σ) ≤ OL
Hg	BL ≤ (700-3σ) < X < (1300+3σ) ≤ OL	BL ≤ (700-3σ) < X < (1300+3σ) ≤ OL	BL ≤ (500-3σ) < X < (1500+3σ) ≤ OL
Br	BL ≤ (300-3σ) < X	---	BL ≤ (250-3σ) < X
Cr	BL ≤ (700-3σ) < X	BL ≤ (700-3σ) < X	BL ≤ (500-3σ) < X

- (c) OL = Over Limit, BL = Below Limit, IN = Inconclusive, LOD = Limit of Detection
- (d) The XRF screening test for RoHS elements – The reading may be different to the actual content in the sample be of non-uniformity composition

- (2) (a) mg/kg = ppm=0.0001%, N.D. = not detected (<MDL), --- = not conducted, \ = not available.
- (b) Unit and Method Detection Limit (MDL) in wet chemical test

Test Items	Pb	Cd	Hg
Units	mg/kg	mg/kg	mg/kg
MDL	2	2	2

The MDL for single compound of PBBs & PBDEs is 5 mg/kg and MDL of Cr⁶⁺ for polymer & composite sample is 2 mg/kg.

- (c) According to IEC 62321:2008, result on Cr⁶⁺ for metal sample is shown as Positive/Negative. Negative = Absence of Cr⁶⁺ coating, Positive = Presence of Cr⁶⁺ coating.
Storage conditions and production date of the tested sample are unavailable and thus results of Cr(VI) represent status of the sample at the time of testing.

This document is issued by the Company under its General Conditions of Service printed overleaf or available on request and accessible at http://www.sgs.com/terms_and_conditions.htm. Attention is drawn to the limitation of liability, indemnification and jurisdiction issues defined therein. Any holder of this document is advised that information contained hereon reflects the Company's findings at the time of its intervention only and within the limits of Client's instructions, if any. The Company's sole responsibility is to its Client and this document does not generate parties to a transaction from exercising all their rights and obligations under the transaction documents. Any unauthorized alteration, forgery or falsification of the content or appearance of this document is unlawful and offenders may be prosecuted to the fullest extent of the law. Unless otherwise stated, the results shown in this test report refer only to the sample(s) tested. This document cannot be reproduced except in full, without prior approval of the Company.



Remark[1]~[3]: According to the declaration from client, the source of Lead in No.7-C, No.8-C & No.61 could be from the copper alloy base, while Lead as an alloying element in copper alloy containing up to 4% Lead by weight is exempted by RoHS regulatory (Directive 2002/95/EC of the European Parliament and of the council of 27 January 2003).

Remark[4]&[5]: According to the declaration from client, the source of Lead in No.123-C & No.129-C could be from the glass material of that electronic component which is exempted by RoHS regulatory (Directive 2002/95/EC of the European parliament and of The council of 27 January 2003)

This document is issued by the Company under its General Conditions of Service printed overleaf or available on request and accessible at http://www.sgs.com/terms_and_conditions.htm. Attention is drawn to the limitation of liability, indemnification and jurisdiction issues defined therein. Any holder of this document is advised that information contained hereon reflects the Company's findings at the time of its intervention only and within the limits of Client's instructions, if any. The Company's sole responsibility is to its Client and this document does not exonerate parties to a transaction from exercising all their rights and obligations under the transaction documents. Any unauthorized alteration, forgery or falsification of the content or appearance of this document is unlawful and offenders may be prosecuted to the fullest extent of the law. Unless otherwise stated, the results shown in this test report refer only to the sample(s) tested. This document cannot be reproduced except in full, without prior approval of the Company.



Photo Index



This document is issued by the Company under its General Conditions of Service printed overleaf or available on request and accessible at http://www.sgs.com/terms_and_conditions.htm. Attention is drawn to the limitation of liability, indemnification and jurisdiction issues defined therein. Any holder of this document is advised that information contained hereon reflects the Company's findings at the time of its intervention only and within the limits of Client's instructions, if any. The Company's sole responsibility is to its Client and this document does not generate parties to a transaction from exercising all their rights and obligations under the transaction documents. Any unauthorized alteration, forgery or falsification of the content or appearance of this document is unlawful and offenders may be prosecuted to the fullest extent of the law. Unless otherwise stated the results shown in this test report refer only to the sample(s) tested. This document cannot be reproduced except in full, without prior approval of the Company.





This document is issued by the Company under its General Conditions of Service printed overleaf or available on request and accessible at http://www.sgs.com/terms_and_conditions.htm. Attention is drawn to the limitation of liability, indemnification and jurisdiction issues defined therein. Any holder of this document is advised that information contained hereon reflects the Company's findings at the time of its intervention only and within the limits of Client's instructions, if any. The Company's sole responsibility is to its Client and this document does not constitute part of a transaction from exercising all their rights and obligations under the transaction documents. Any unauthorized alteration, forgery or falsification of the content or appearance of this document is unlawful and offenders may be prosecuted to the fullest extent of the law. Unless otherwise stated, the results shown in this test report refer only to the sample(s) tested. This document cannot be reproduced except in full, without prior approval of the Company.



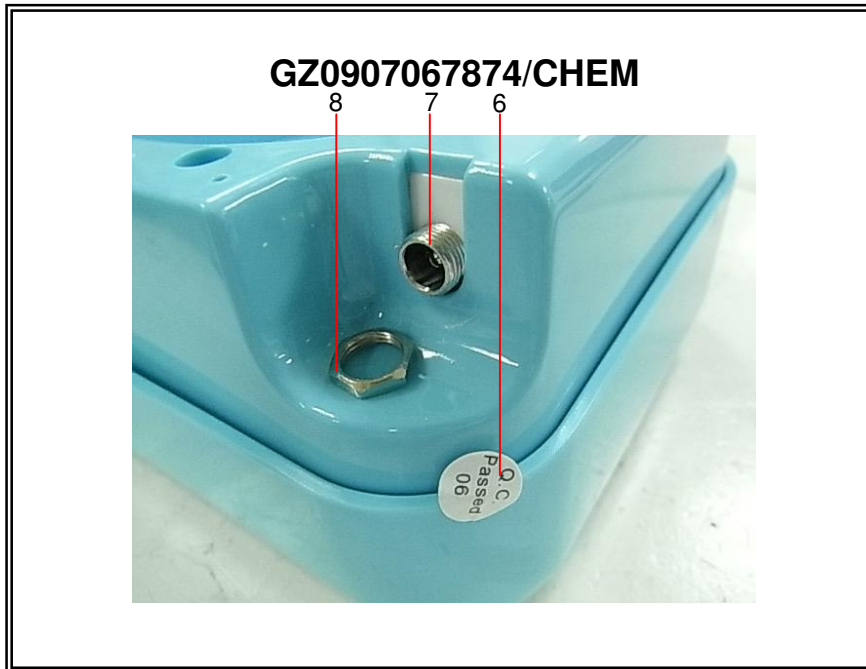

This document is issued by the Company under its General Conditions of Service printed overleaf or available on request and accessible at http://www.sgs.com/terms_and_conditions.htm. Attention is drawn to the limitation of liability, indemnification and jurisdiction issues defined therein. Any holder of this document is advised that information contained hereon reflects the Company's findings at the time of its intervention only and within the limits of Client's instructions, if any. The Company's sole responsibility is to its Client and this document does not constitute parties to a transaction from exercising all their rights and obligations under the transaction documents. Any unauthorized alteration, forgery or falsification of the content or appearance of this document is unlawful and offenders may be prosecuted to the fullest extent of the law. Unless otherwise stated, the results shown in this test report refer only to the sample(s) tested. This document cannot be reproduced except in full, without prior approval of the Company.



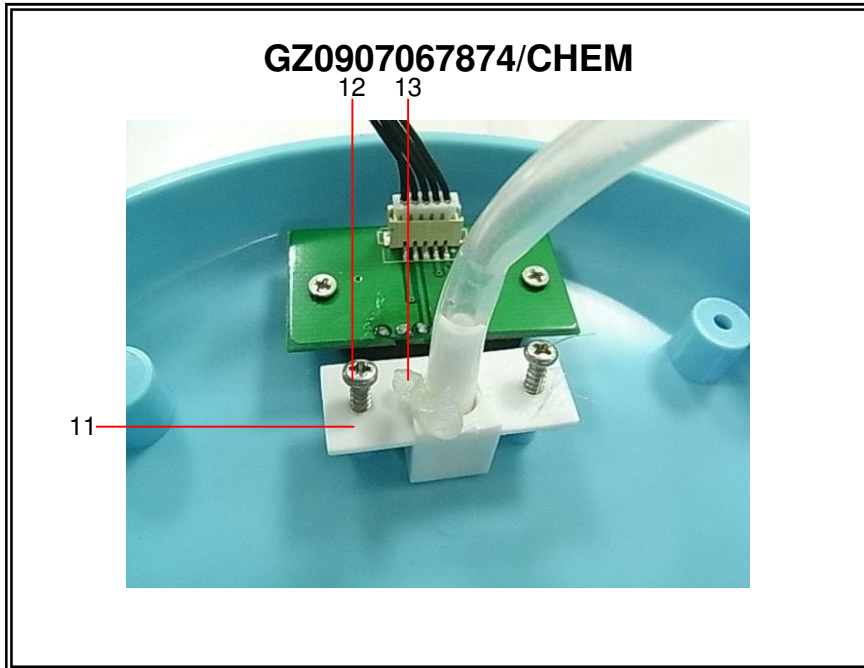

This document is issued by the Company under its General Conditions of Service printed overleaf or available on request and accessible at http://www.sgs.com/terms_and_conditions.htm. Attention is drawn to the limitation of liability, indemnification and jurisdiction issues defined therein. Any holder of this document is advised that information contained hereon reflects the Company's findings at the time of its intervention only and within the limits of Client's instructions, if any. The Company's sole responsibility is to its Client and this document does not constitute parties to a transaction from exercising all their rights and obligations under the transaction documents. Any unauthorized alteration, forgery or falsification of the content or appearance of this document is unlawful and offenders may be prosecuted to the fullest extent of the law. Unless otherwise stated, the results shown in this test report refer only to the sample(s) tested. This document cannot be reproduced except in full, without prior approval of the Company.



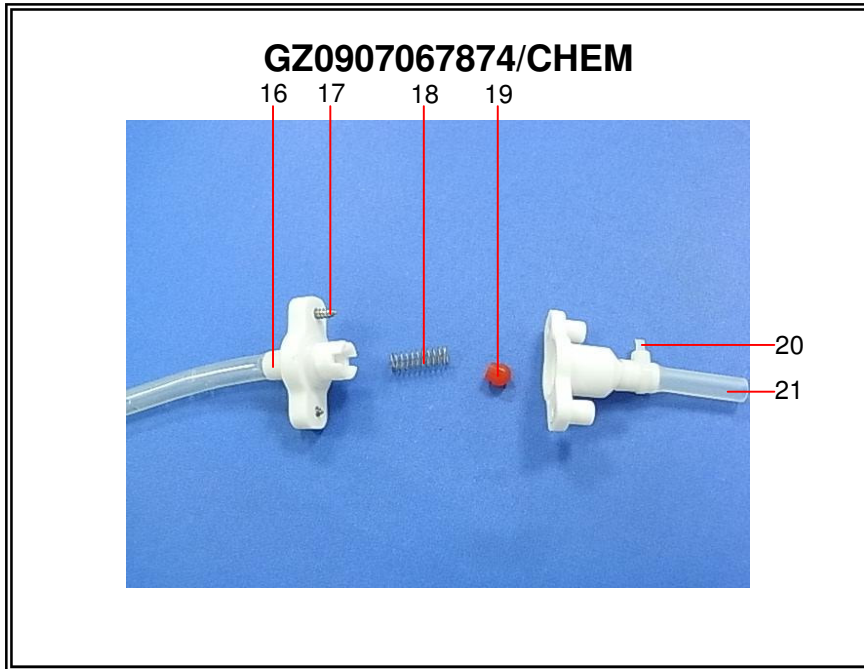
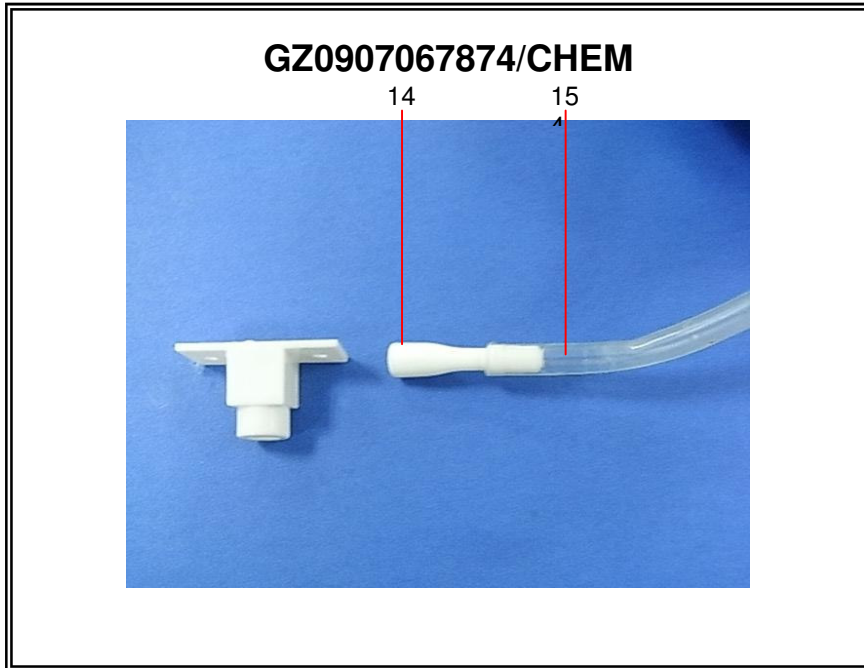

This document is issued by the Company under its General Conditions of Service printed overleaf or available on request and accessible at http://www.sgs.com/terms_and_conditions.htm. Attention is drawn to the limitation of liability, indemnification and jurisdiction issues defined therein. Any holder of this document is advised that information contained hereon reflects the Company's findings at the time of its intervention only and within the limits of Client's instructions, if any. The Company's sole responsibility is to its Client and this document does not generate parties to a transaction from exercising all their rights and obligations under the transaction documents. Any unauthorized alteration, forgery or falsification of the content or appearance of this document is unlawful and offenders may be prosecuted to the fullest extent of the law.

Unless otherwise stated, the results shown in this test report refer only to the sample(s) tested. This document cannot be reproduced except in full, without prior approval of the Company.



GZ0907067874/CHEM

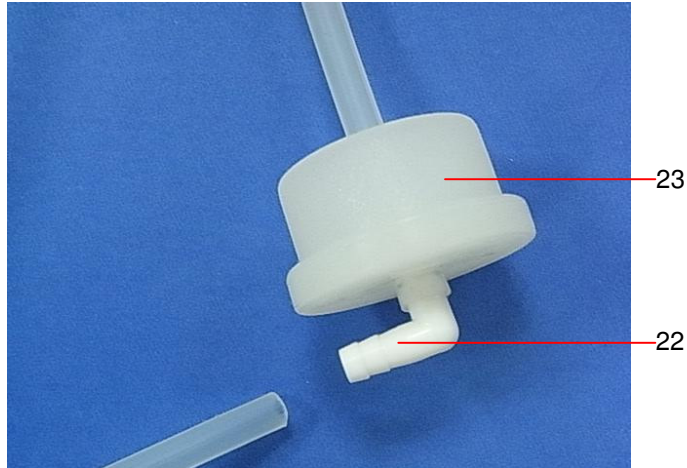

GZ0907067874/CHEM

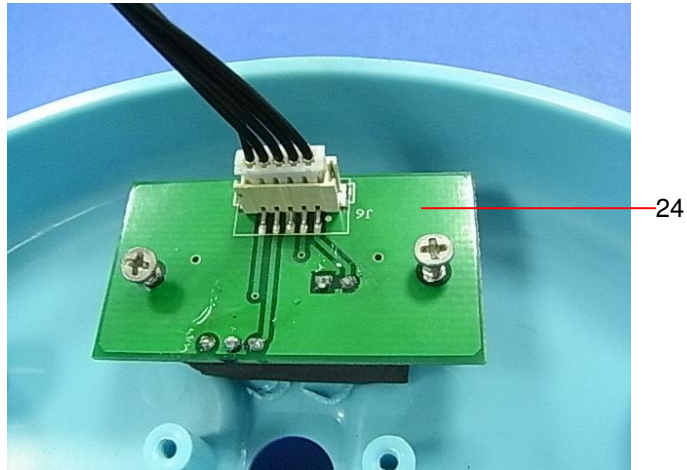

This document is issued by the Company under its General Conditions of Service printed overleaf or available on request and accessible at http://www.sgs.com/terms_and_conditions.htm. Attention is drawn to the limitation of liability, indemnification and jurisdiction issues defined therein. Any holder of this document is advised that information contained hereon reflects the Company's findings at the time of its intervention only and within the limits of Client's instructions, if any. The Company's sole responsibility is to its Client and this document does not constitute part of a transaction from exercising all their rights and obligations under the transaction documents. Any unauthorized alteration, forgery or falsification of the content or appearance of this document is unlawful and offenders may be prosecuted to the fullest extent of the law. Unless otherwise stated, the results shown in this test report refer only to the sample(s) tested. This document cannot be reproduced except in full, without prior approval of the Company.



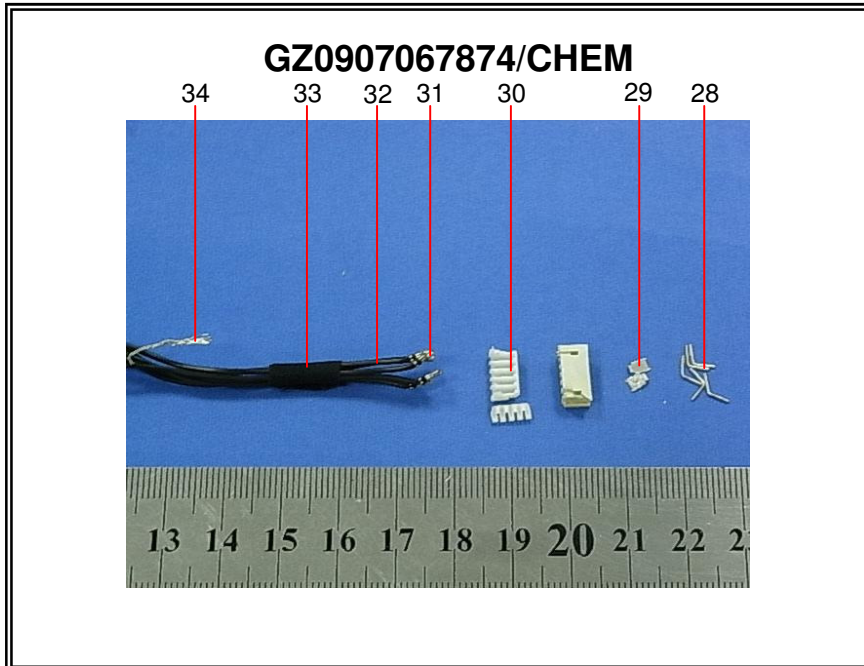
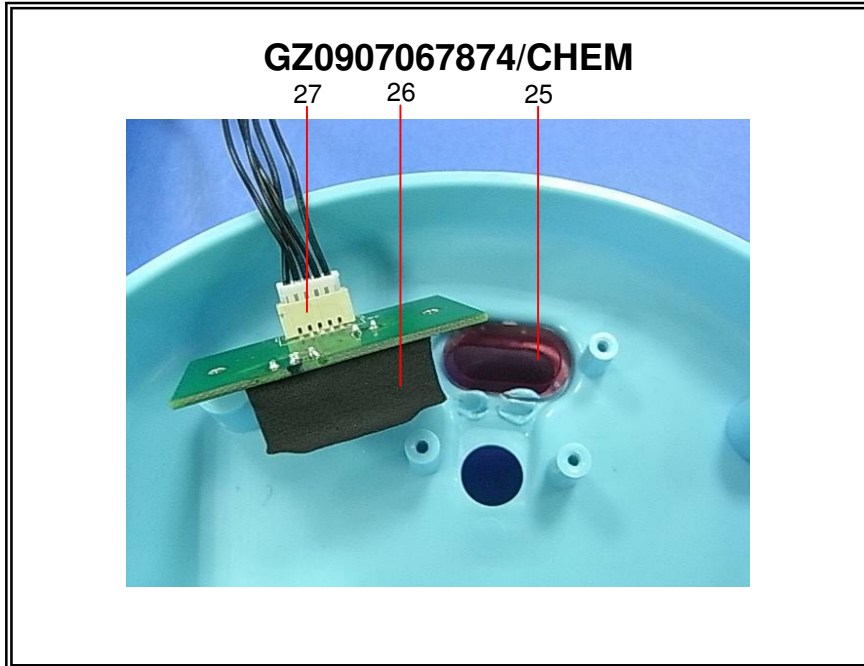

This document is issued by the Company under its General Conditions of Service printed overleaf or available on request and accessible at http://www.sgs.com/terms_and_conditions.htm. Attention is drawn to the limitation of liability, indemnification and jurisdiction issues defined therein. Any holder of this document is advised that information contained hereon reflects the Company's findings at the time of its intervention only and within the limits of Client's instructions, if any. The Company's sole responsibility is to its Client and this document does not constitute parties to a transaction from exercising all their rights and obligations under the transaction documents. Any unauthorized alteration, forgery or falsification of the content or appearance of this document is unlawful and offenders may be prosecuted to the fullest extent of the law.



GZ0907067874/CHEM

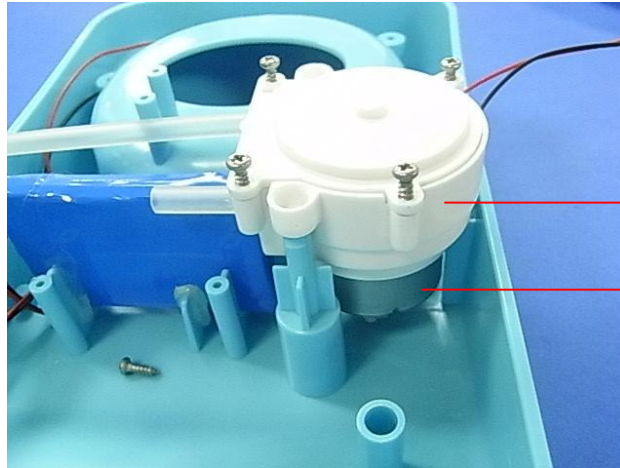

GZ0907067874/CHEM

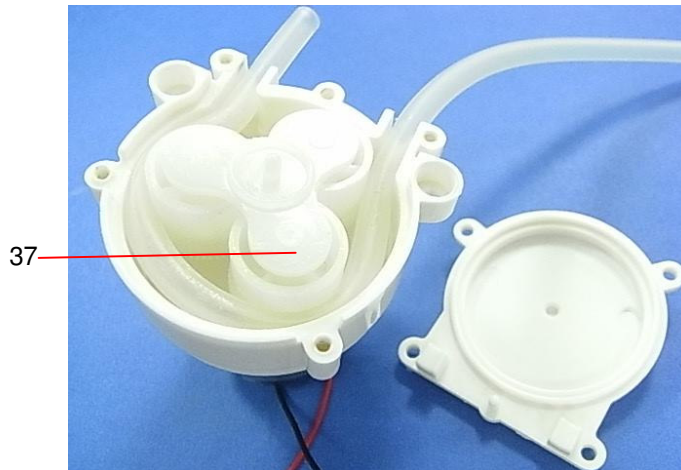

This document is issued by the Company under its General Conditions of Service printed overleaf or available on request and accessible at http://www.sgs.com/terms_and_conditions.htm. Attention is drawn to the limitation of liability, indemnification and jurisdiction issues defined therein. Any holder of this document is advised that information contained hereon reflects the Company's findings at the time of its intervention only and within the limits of Client's instructions, if any. The Company's sole responsibility is to its Client and this document does not constitute part of a transaction from exercising all their rights and obligations under the transaction documents. Any unauthorized alteration, forgery or falsification of the content or appearance of this document is unlawful and offenders may be prosecuted to the fullest extent of the law. Unless otherwise stated, the results shown in this test report refer only to the sample(s) tested. This document cannot be reproduced except in full, without prior approval of the Company.



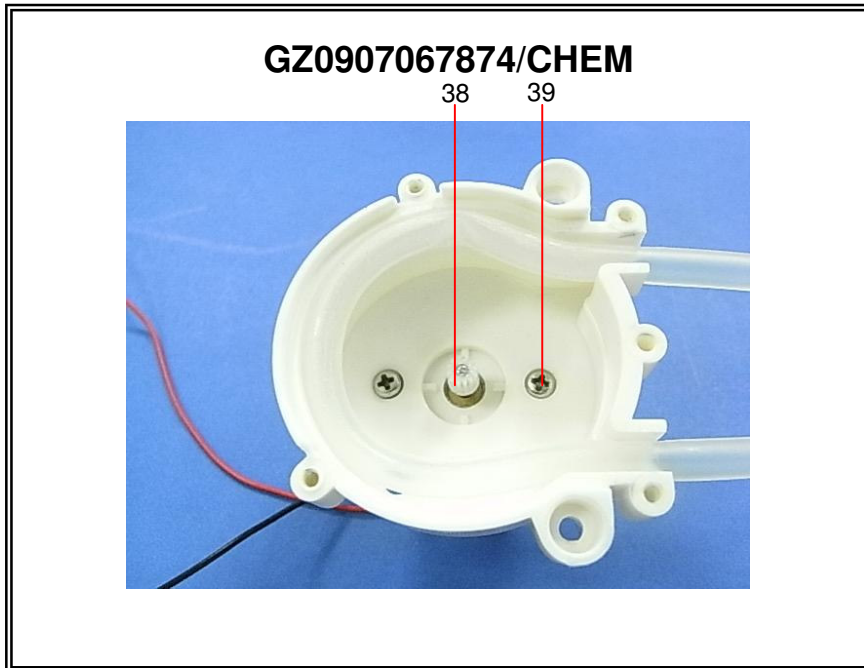

This document is issued by the Company under its General Conditions of Service printed overleaf or available on request and accessible at http://www.sgs.com/terms_and_conditions.htm. Attention is drawn to the limitation of liability, indemnification and jurisdiction issues defined therein. Any holder of this document is advised that information contained hereon reflects the Company's findings at the time of its intervention only and within the limits of Client's instructions, if any. The Company's sole responsibility is to its Client and this document does not constitute parties to a transaction from exercising all their rights and obligations under the transaction documents. Any unauthorized alteration, forgery or falsification of the content or appearance of this document is unlawful and offenders may be prosecuted to the fullest extent of the law. Unless otherwise stated, the results shown in this test report refer only to the sample(s) tested. This document cannot be reproduced except in full, without prior approval of the Company.



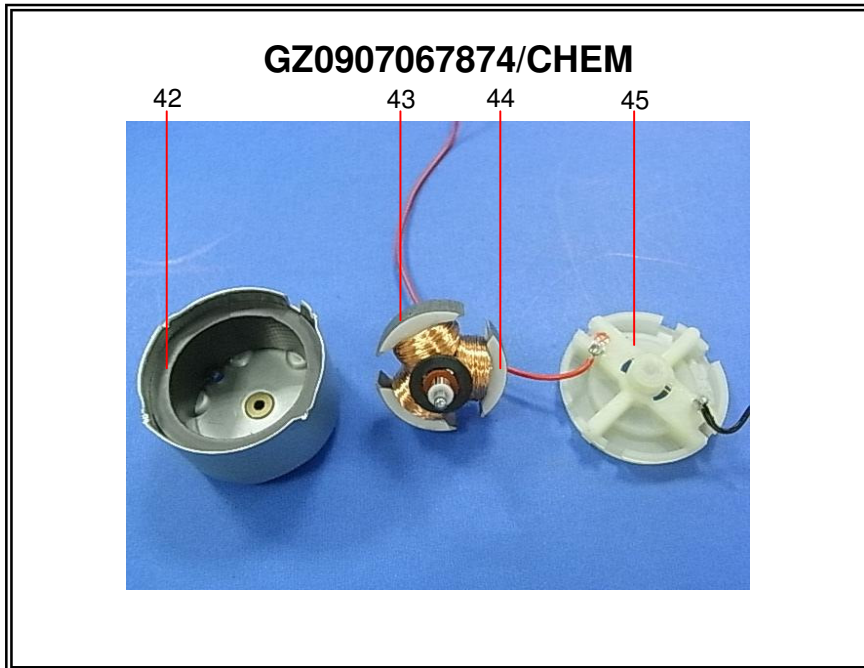

This document is issued by the Company under its General Conditions of Service printed overleaf or available on request and accessible at http://www.sgs.com/terms_and_conditions.htm. Attention is drawn to the limitation of liability, indemnification and jurisdiction issues defined therein. Any holder of this document is advised that information contained herein reflects the Company's findings at the time of its intervention only and within the limits of Client's instructions, if any. The Company's sole responsibility is to its Client and this document does not constitute part of a transaction from exercising all their rights and obligations under the transaction documents. Any unauthorized alteration, forgery or falsification of the content or appearance of this document is unlawful and offenders may be prosecuted to the fullest extent of the law.



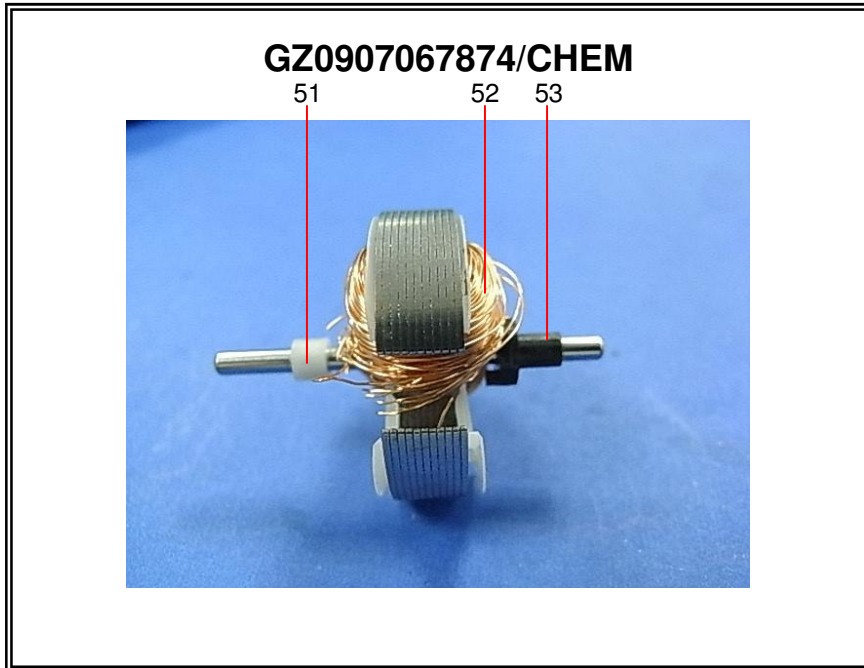

This document is issued by the Company under its General Conditions of Service printed overleaf or available on request and accessible at http://www.sgs.com/terms_and_conditions.htm. Attention is drawn to the limitation of liability, indemnification and jurisdiction issues defined therein. Any holder of this document is advised that information contained herein reflects the Company's findings at the time of its intervention only and within the limits of Client's instructions, if any. The Company's sole responsibility is to its Client and this document does not generate parties to a transaction from exercising all their rights and obligations under the transaction documents. Any unauthorized alteration, forgery or falsification of the content or appearance of this document is unlawful and offenders may be prosecuted to the fullest extent of the law. Unless otherwise stated, the results shown in this test report refer only to the sample(s) tested. This document cannot be reproduced except in full, without prior approval of the Company.



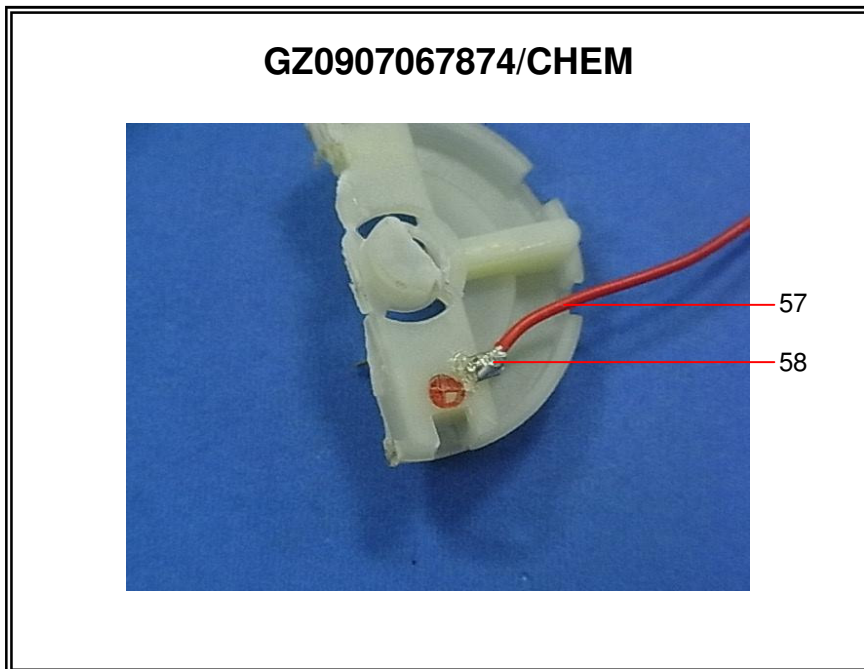
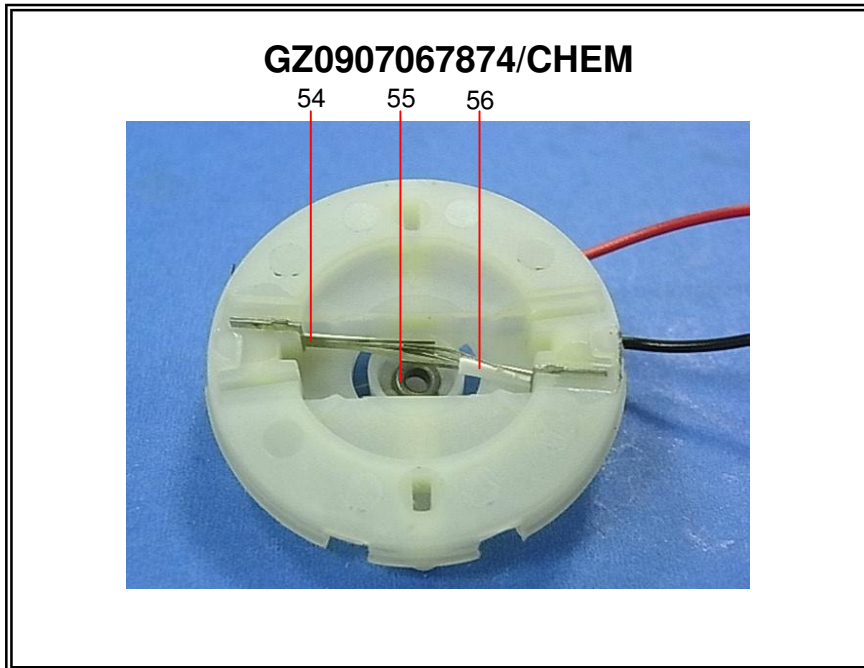

This document is issued by the Company under its General Conditions of Service printed overleaf or available on request and accessible at http://www.sgs.com/terms_and_conditions.htm. Attention is drawn to the limitation of liability, indemnification and jurisdiction issues defined therein. Any holder of this document is advised that information contained hereon reflects the Company's findings at the time of its intervention only and within the limits of Client's instructions, if any. The Company's sole responsibility is to its Client and this document does not exonerate parties to a transaction from exercising all their rights and obligations under the transaction documents. Any unauthorized alteration, forgery or falsification of the content or appearance of this document is unlawful and offenders may be prosecuted to the fullest extent of the law. Unless otherwise stated, the results shown in this test report refer only to the sample(s) tested. This document cannot be reproduced except in full, without prior approval of the Company.



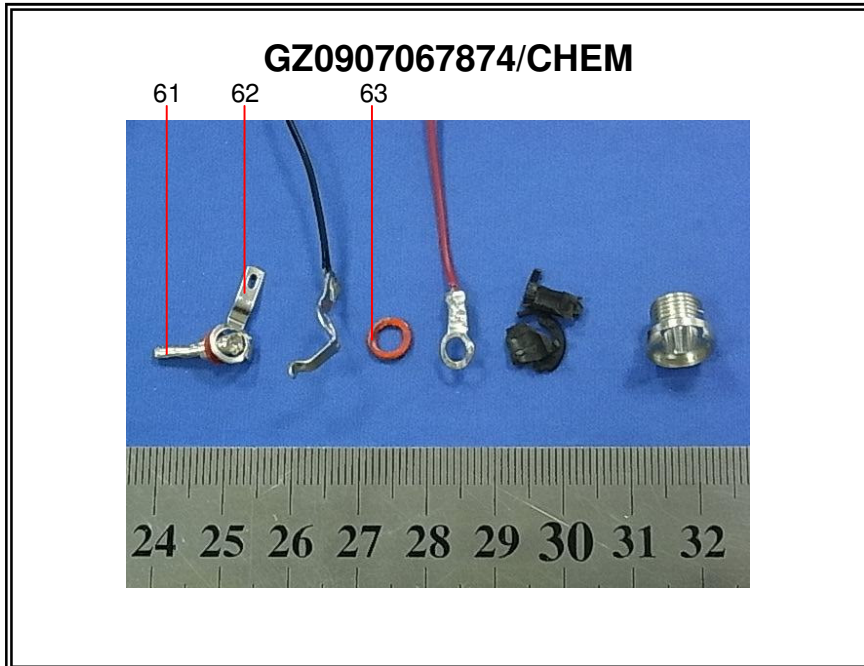

This document is issued by the Company under its General Conditions of Service printed overleaf or available on request and accessible at http://www.sgs.com/terms_and_conditions.htm. Attention is drawn to the limitation of liability, indemnification and jurisdiction issues defined therein. Any holder of this document is advised that information contained hereon reflects the Company's findings at the time of its intervention only and within the limits of Client's instructions, if any. The Company's sole responsibility is to its Client and this document does not constitute parties to a transaction from exercising all their rights and obligations under the transaction documents. Any unauthorized alteration, forgery or falsification of the content or appearance of this document is unlawful and offenders may be prosecuted to the fullest extent of the law.



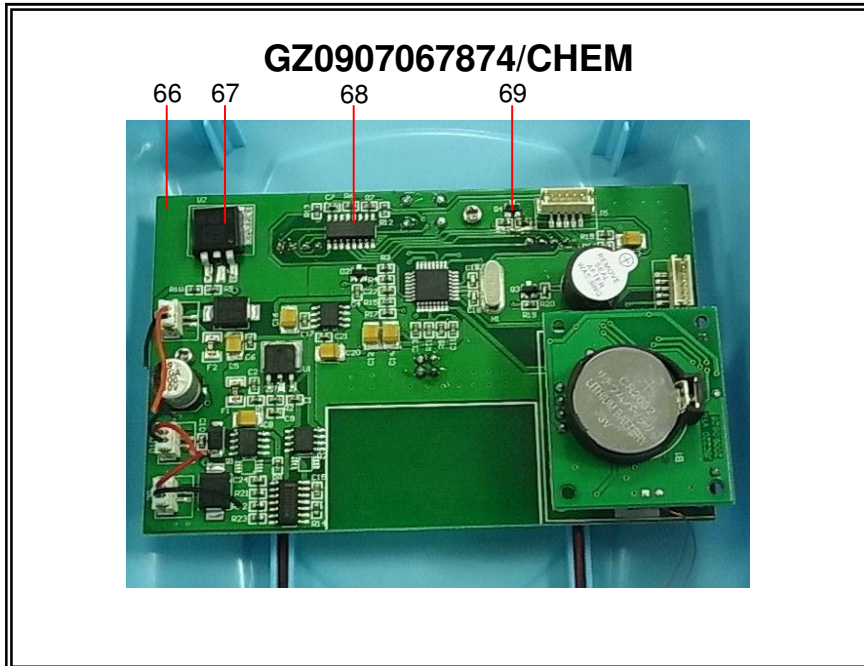
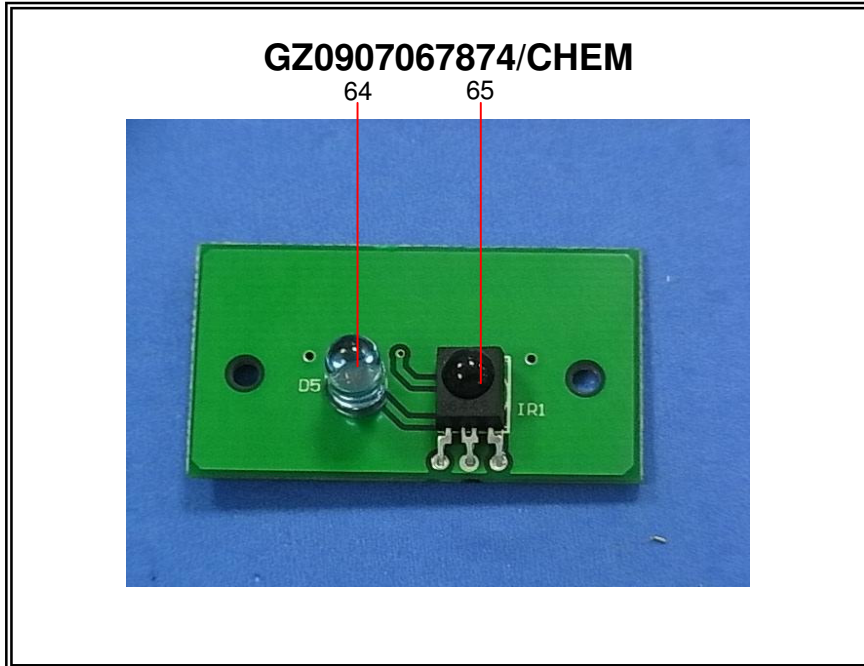

This document is issued by the Company under its General Conditions of Service printed overleaf or available on request and accessible at http://www.sgs.com/terms_and_conditions.htm. Attention is drawn to the limitation of liability, indemnification and jurisdiction issues defined therein. Any holder of this document is advised that information contained hereon reflects the Company's findings at the time of its intervention only and within the limits of Client's instructions, if any. The Company's sole responsibility is to its Client and this document does not constitute part of a transaction from exercising all their rights and obligations under the transaction documents. Any unauthorized alteration, forgery or falsification of the content or appearance of this document is unlawful and offenders may be prosecuted to the fullest extent of the law.



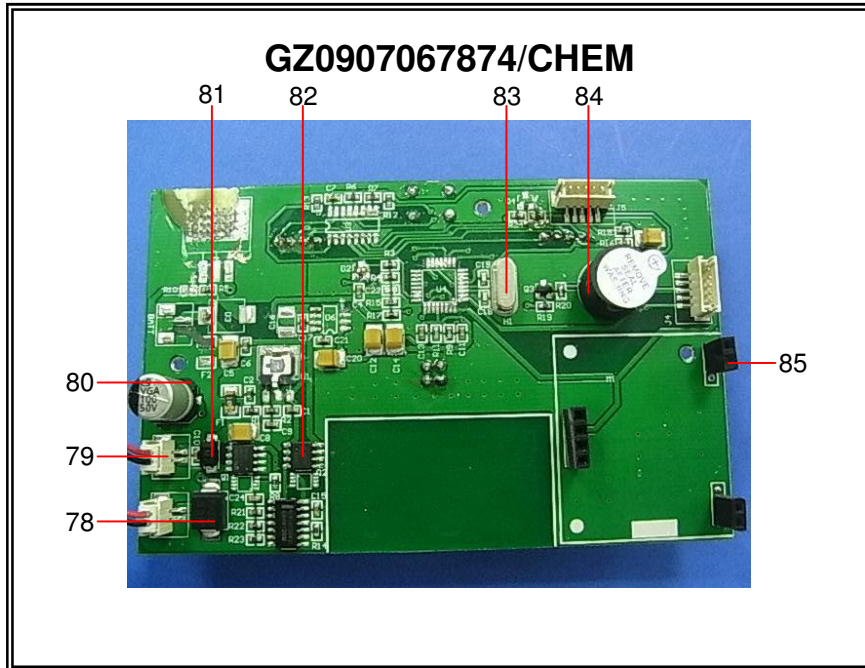
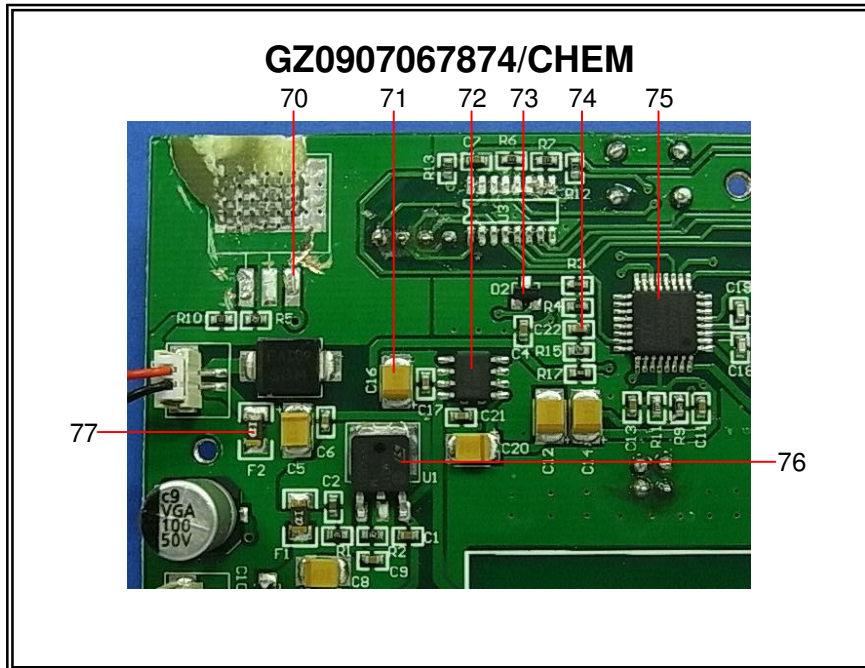

This document is issued by the Company under its General Conditions of Service printed overleaf or available on request and accessible at http://www.sgs.com/terms_and_conditions.htm. Attention is drawn to the limitation of liability, indemnification and jurisdiction issues defined therein. Any holder of this document is advised that information contained hereon reflects the Company's findings at the time of its intervention only and within the limits of Client's instructions, if any. The Company's sole responsibility is to its Client and this document does not generate parties to a transaction from exercising all their rights and obligations under the transaction documents. Any unauthorized alteration, forgery or falsification of the content or appearance of this document is unlawful and offenders may be prosecuted to the fullest extent of the law.

Unless otherwise stated the results shown in this test report refer only to the sample(s) tested. This document cannot be reproduced except in full, without prior approval of the Company.



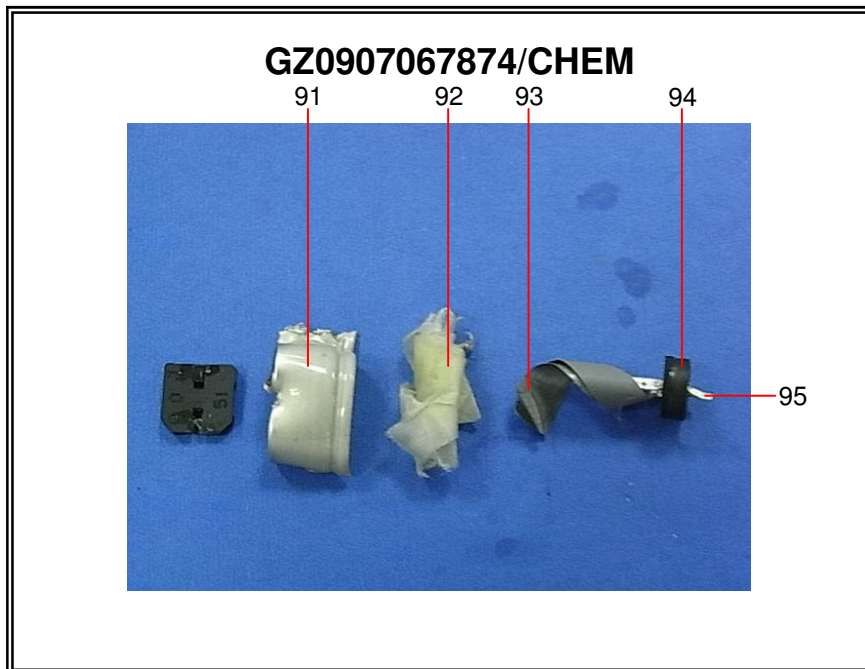
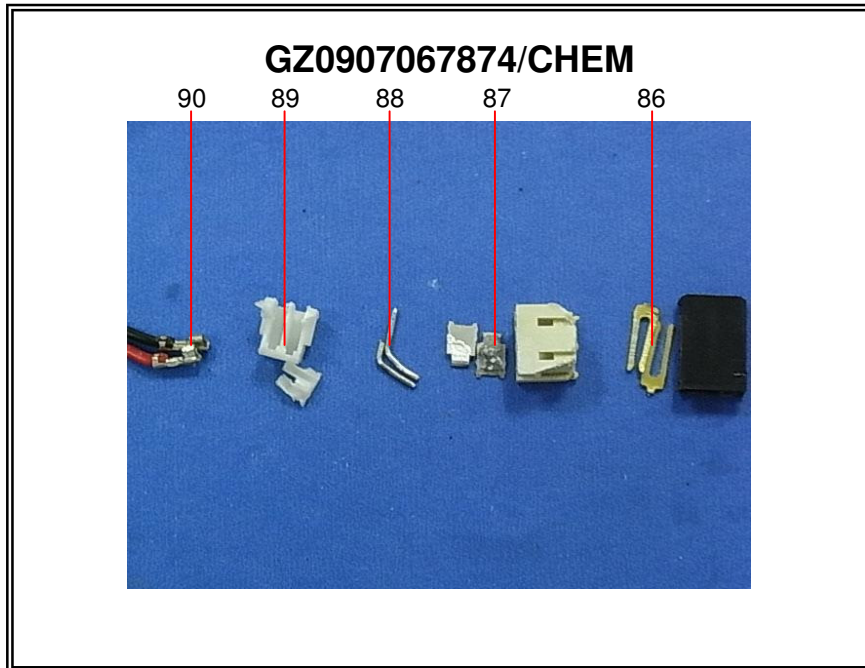

This document is issued by the Company under its General Conditions of Service printed overleaf or available on request and accessible at http://www.sgs.com/terms_and_conditions.htm. Attention is drawn to the limitation of liability, indemnification and jurisdiction issues defined therein. Any holder of this document is advised that information contained hereon reflects the Company's findings at the time of its intervention only and within the limits of Client's instructions, if any. The Company's sole responsibility is to its Client and this document does not exonerate parties to a transaction from exercising all their rights and obligations under the transaction documents. Any unauthorized alteration, forgery or falsification of the content or appearance of this document is unlawful and offenders may be prosecuted to the fullest extent of the law. Unless otherwise stated, the results shown in this test report refer only to the sample(s) tested. This document cannot be reproduced except in full, without prior approval of the Company.



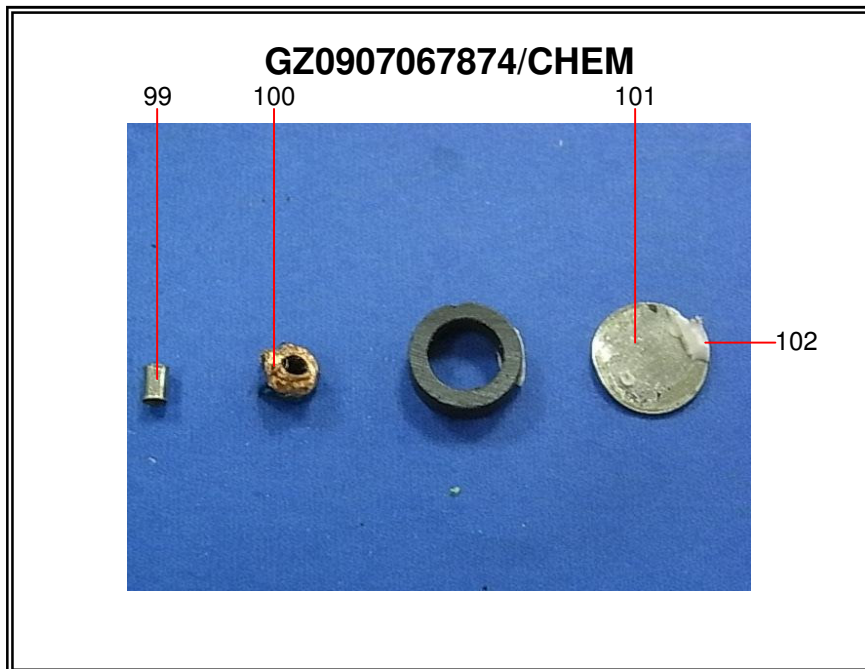
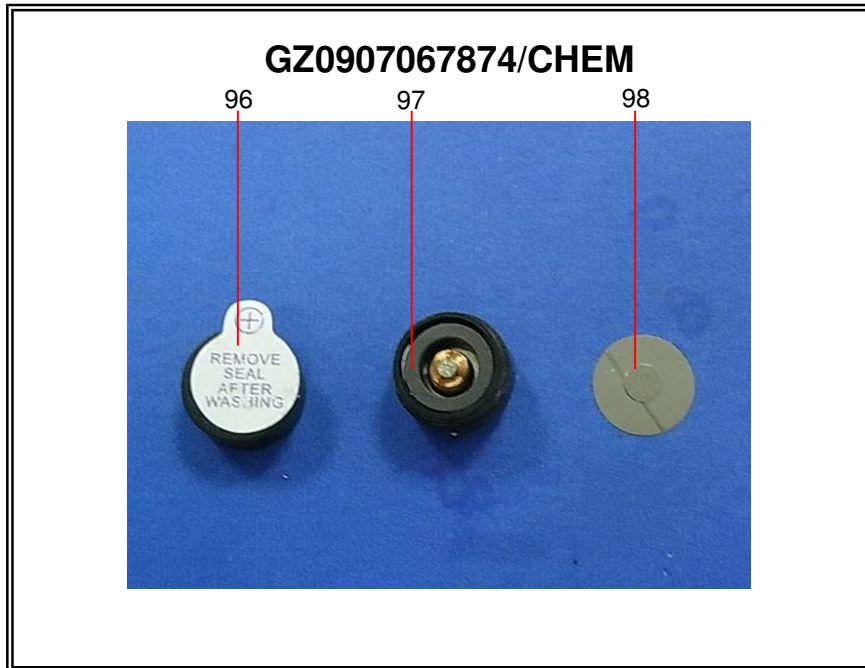

This document is issued by the Company under its General Conditions of Service printed overleaf or available on request and accessible at http://www.sgs.com/terms_and_conditions.htm. Attention is drawn to the limitation of liability, indemnification and jurisdiction issues defined therein. Any holder of this document is advised that information contained hereon reflects the Company's findings at the time of its intervention only and within the limits of Client's instructions, if any. The Company's sole responsibility is to its Client and this document does not exonerate parties to a transaction from exercising all their rights and obligations under the transaction documents. Any unauthorized alteration, forgery or falsification of the content or appearance of this document is unlawful and offenders may be prosecuted to the fullest extent of the law.

Unless otherwise stated, the results shown in this test report refer only to the sample(s) tested. This document cannot be reproduced except in full, without prior approval of the Company.



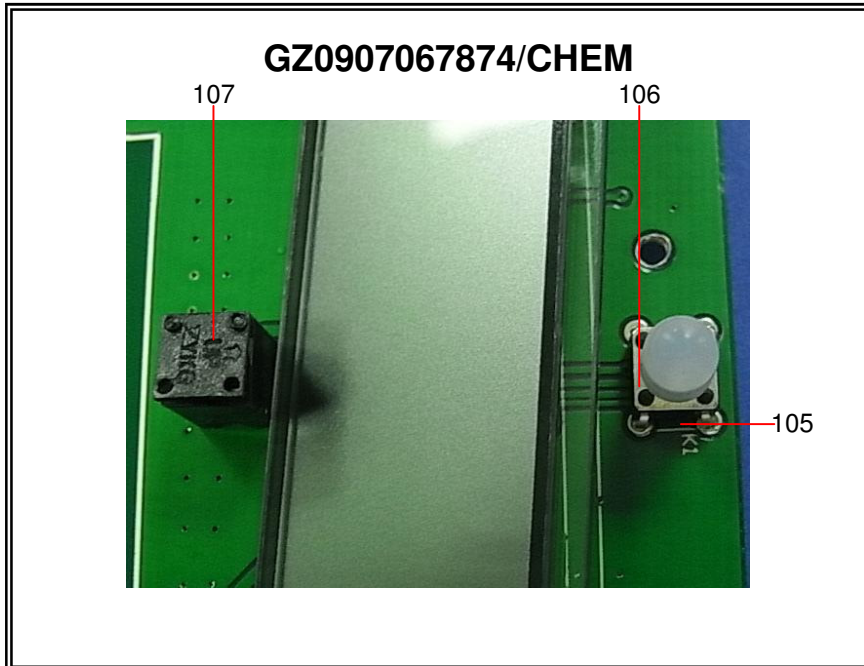
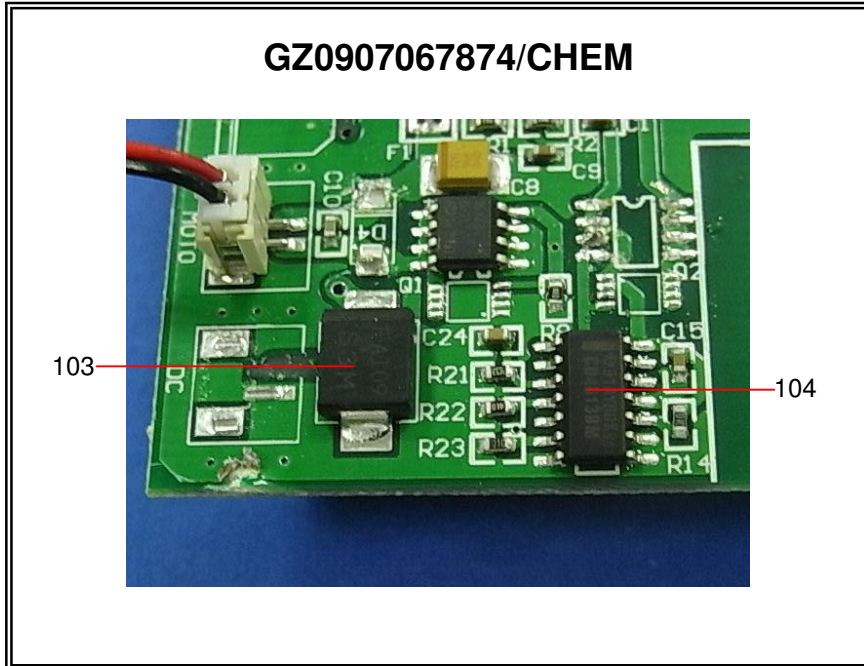

This document is issued by the Company under its General Conditions of Service printed overleaf or available on request and accessible at http://www.sgs.com/terms_and_conditions.htm. Attention is drawn to the limitation of liability, indemnification and jurisdiction issues defined therein. Any holder of this document is advised that information contained hereon reflects the Company's findings at the time of its intervention only and within the limits of Client's instructions, if any. The Company's sole responsibility is to its Client and this document does not constitute part of a transaction from exercising all their rights and obligations under the transaction documents. Any unauthorized alteration, forgery or falsification of the content or appearance of this document is unlawful and offenders may be prosecuted to the fullest extent of the law. Unless otherwise stated, the results shown in this test report refer only to the sample(s) tested. This document cannot be reproduced except in full, without prior approval of the Company.



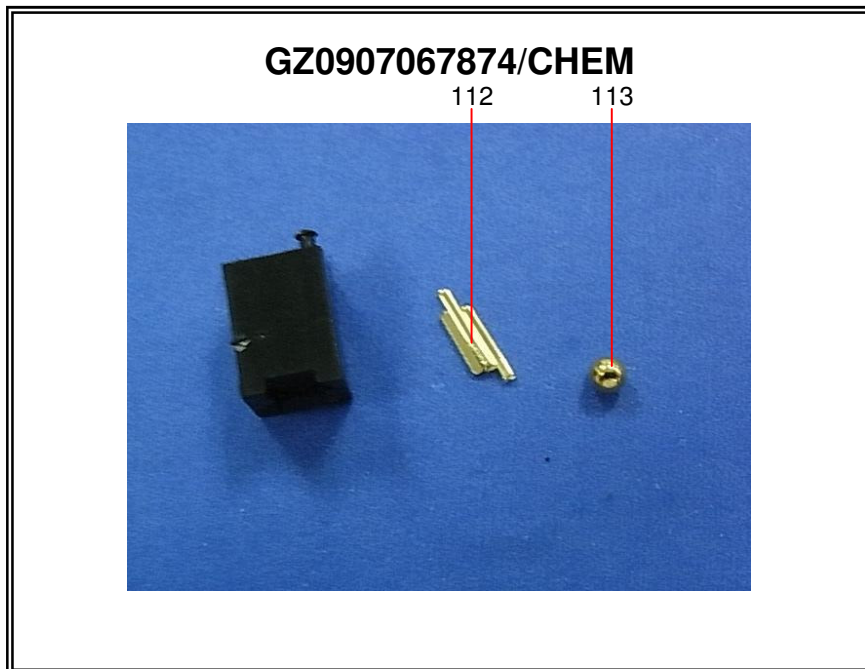

This document is issued by the Company under its General Conditions of Service printed overleaf or available on request and accessible at http://www.sgs.com/terms_and_conditions.htm. Attention is drawn to the limitation of liability, indemnification and jurisdiction issues defined therein. Any holder of this document is advised that information contained hereon reflects the Company's findings at the time of its intervention only and within the limits of Client's instructions, if any. The Company's sole responsibility is to its Client and this document does not exonerate parties to a transaction from exercising all their rights and obligations under the transaction documents. Any unauthorized alteration, forgery or falsification of the content or appearance of this document is unlawful and offenders may be prosecuted to the fullest extent of the law. Unless otherwise stated, the results shown in this test report refer only to the sample(s) tested. This document cannot be reproduced except in full, without prior approval of the Company.



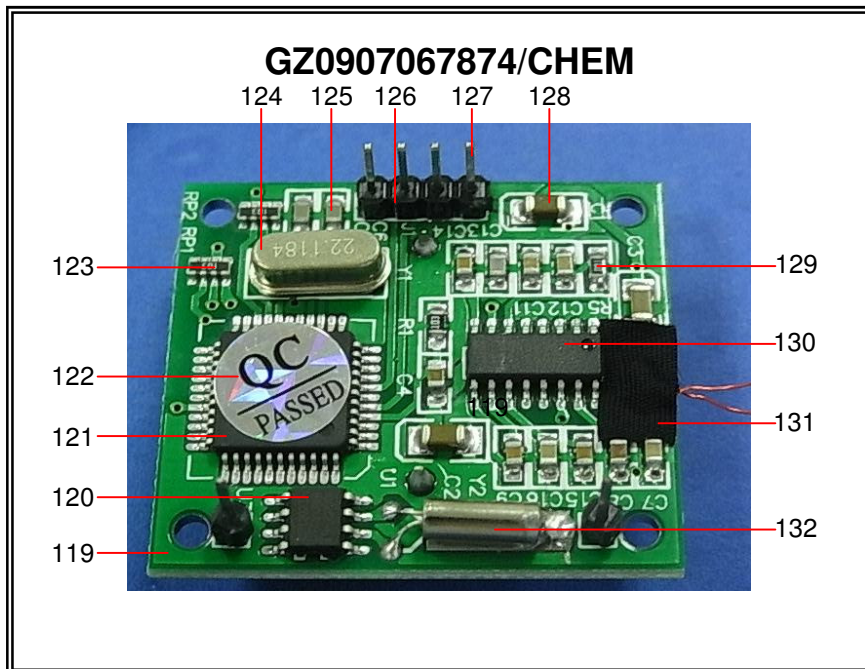
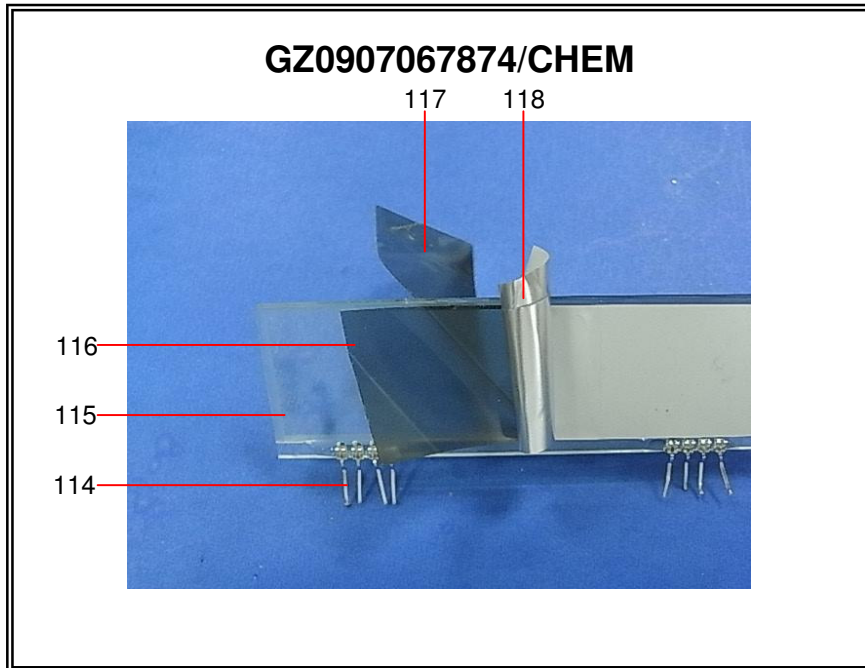

This document is issued by the Company under its General Conditions of Service printed overleaf or available on request and accessible at http://www.sgs.com/terms_and_conditions.htm. Attention is drawn to the limitation of liability, indemnification and jurisdiction issues defined therein. Any holder of this document is advised that information contained hereon reflects the Company's findings at the time of its intervention only and within the limits of Client's instructions, if any. The Company's sole responsibility is to its Client and this document does not constitute parties to a transaction from exercising all their rights and obligations under the transaction documents. Any unauthorized alteration, forgery or falsification of the content or appearance of this document is unlawful and offenders may be prosecuted to the fullest extent of the law.



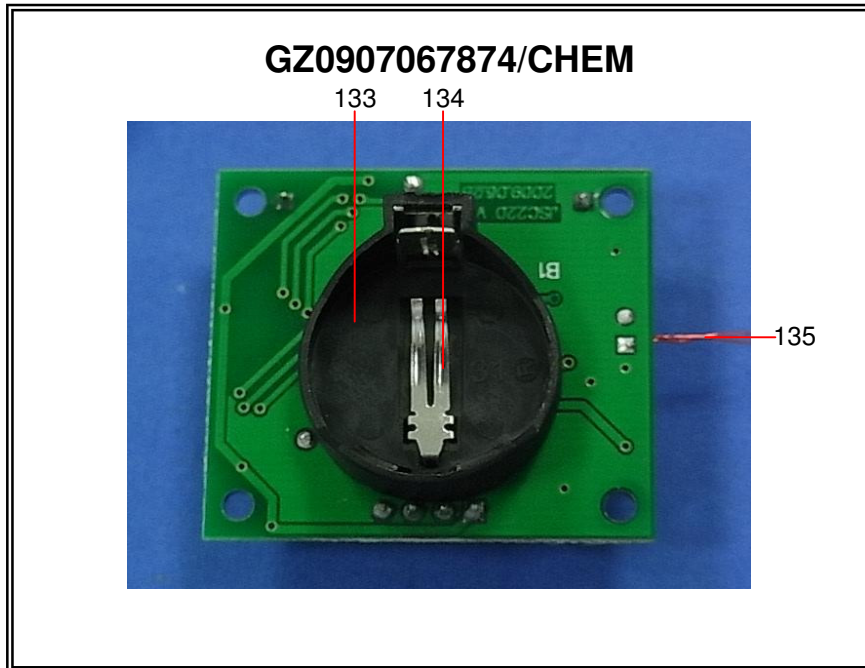

This document is issued by the Company under its General Conditions of Service printed overleaf or available on request and accessible at http://www.sgs.com/terms_and_conditions.htm. Attention is drawn to the limitation of liability, indemnification and jurisdiction issues defined therein. Any holder of this document is advised that information contained hereon reflects the Company's findings at the time of its intervention only and within the limits of Client's instructions, if any. The Company's sole responsibility is to its Client and this document does not generate parties to a transaction from exercising all their rights and obligations under the transaction documents. Any unauthorized alteration, forgery or falsification of the content or appearance of this document is unlawful and offenders may be prosecuted to the fullest extent of the law. Unless otherwise stated, the results shown in this test report refer only to the sample(s) tested. This document cannot be reproduced except in full, without prior approval of the Company.



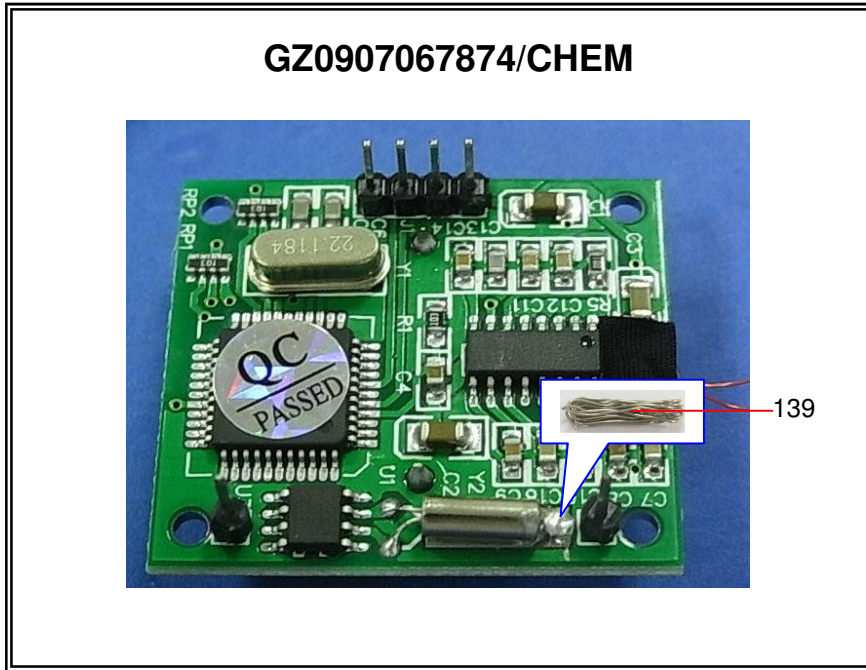

(SGS authenticate the photo on original report only)

*** End of Report ***

This document is issued by the Company under its General Conditions of Service printed overleaf or available on request and accessible at http://www.sgs.com/terms_and_conditions.htm. Attention is drawn to the limitation of liability, indemnification and jurisdiction issues defined therein. Any holder of this document is advised that information contained herein reflects the Company's findings at the time of its intervention only and within the limits of Client's instructions, if any. The Company's sole responsibility is to its Client and this document does not constitute parties to a transaction from exercising all their rights and obligations under the transaction documents. Any unauthorized alteration, forgery or falsification of the content or appearance of this document is unlawful and offenders may be prosecuted to the fullest extent of the law. Unless otherwise stated, the results shown in this test report refer only to the sample(s) tested. This document cannot be reproduced except in full, without prior approval of the Company.

